



## User Guide

### Selected Version



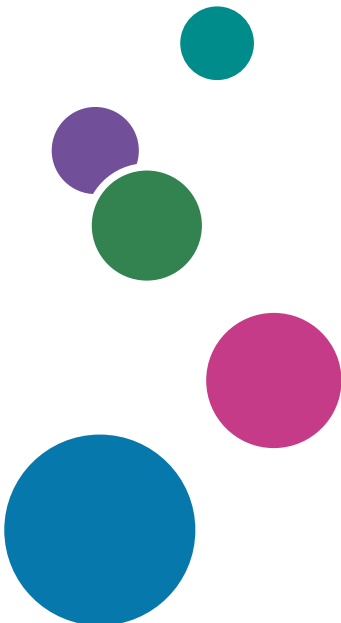

Getting Started	1
Copy	2
Fax	3
Print	4
Scan	5
Document Server	6
Web Image Monitor	7
Adding Paper and Toner	8
Troubleshooting	9
Information for This Machine	10

For information not found in this manual, see the online manuals available on our web site (<https://www.ricoh.com/>) or via the control panel.





# TABLE OF CONTENTS

How to Read This Manuals.....	7
Symbols Used in This Manuals.....	7
<b>1. Getting Started</b>	
Names of Major Features.....	9
Model-Specific Information.....	10
Guide to Names and Functions of Components.....	11
Guide to Components.....	11
Connecting and Setting the Network.....	18
Setting Wired LAN.....	18
Setting Wireless LAN.....	20
Connecting the USB Interface.....	30
Connecting to the USB (Type B) Interface.....	30
Connecting a Device to the Machine's USB Host Interface.....	30
Connecting the Machine to a Telephone Line and Telephone/Handset.....	32
Connecting the Telephone Line  <b>Region A</b> (mainly Europe and Asia).....	32
Connecting the Telephone Line  <b>Region B</b> (mainly North America).....	33
Selecting the Line Type.....	34
Settings Needed for Each Function.....	36
Guide to Functions of the Machine's External Options  <b>Region A</b> (mainly Europe and Asia).....	37
Guide to Functions of the Machine's External Options  <b>Region B</b> (mainly North America).....	38
Order of Option Installation.....	39
Attaching the Paper Feed Unit.....	40
The number of tray that you can install.....	41
Installing the Offline Stapler.....	43
Installing the Wireless LAN interface board.....	47
Installing the IEEE 1284 interface board.....	48
Connecting to the IEEE 1284 Interface.....	49
Installing the Extended USB board.....	50
Installing the USB device server.....	51
Procedure for installing the USB device server.....	51
Connecting to the Extra Ethernet Interface with the USB Device Server Option.....	52
Specifying an IP address for the USB Device Server.....	54
Installing the File Format Converter.....	57

---

Installing SD Card Options.....	58
Installing the Handset  (mainly North America).....	60
Connecting the handset.....	60
Connecting the telephone.....	64
Guide to the Names and Functions of the Machine's Control Panel.....	65
Changing the Display Language.....	66
How to Use the [Home] Screen.....	67
Possible Operations on the Standard Application Screen.....	69
Adding Shortcuts to the [Home] Screen.....	71
Adding Shortcuts to Bookmarks on the [Home] Screen.....	71
Adding Shortcuts to Programs to the [Home] Screen.....	72
Adding Widgets to the [Home] Screen.....	72
How to Use Each Application.....	73
[Copy] (standard) Screen.....	74
[Fax] (standard) Screen.....	76
[Scanner] (standard) Screen.....	82
Registering Frequently Used Functions.....	88
Turning On/Off the Power.....	91
Turning On/Off the Main Power.....	91
Logging In the Machine.....	93
User Code Authentication.....	93
Logging In/Out Using the Control Panel.....	93
Placing Originals.....	95
Placing Originals on the Exposure Glass.....	95
Placing Originals in the Auto Document Feeder.....	95

## 2. Copy

---

Basic Procedure.....	97
Auto Reduce / Enlarge.....	98
Duplex Copying.....	99
Specifying the Original and Copy Orientation.....	100
Combined Copying.....	102
One-Sided Combine.....	103
Two-Sided Combine.....	104



---

Copying Onto Custom Size Paper.....	106
Copying onto Envelopes.....	107
Sort.....	108
Changing the Number of Sets.....	108
Storing Data in the Document Server.....	109

### 3. Fax

---

Basic Procedure for Fax Transmissions (Memory Transmission).....	111
Registering a Fax Destination.....	111
Changing or Deleting a Fax Destination.....	114
Transmitting while Checking Connection to Destination (Immediate Transmission).....	116
Canceling a Fax Transmission.....	117
Canceling a Transmission Before the Original Is Scanned.....	117
Canceling a Transmission While the Original Is Being Scanned.....	117
Canceling a Transmission After the Original Is Scanned.....	117
Storing a Fax Document.....	119
Sending Stored Fax Documents.....	120
Printing the Records Manually.....	122

### 4. Print

---

Installing the Printer Driver for Network Connection (Windows).....	123
Installing the PCL 6 Printer Driver from the CD-ROM.....	123
Installing the Printer Driver for USB Connection (Windows).....	127
Installing the Printer Driver from the CD-ROM.....	127
Displaying the Printer Driver Properties.....	130
Standard Printing.....	131
When Using the PCL 6 Printer Driver.....	131
Printing on Both Sides of Sheets.....	135
How to Print on Both Sides of the Paper (When Using the PCL 6 Printer Driver).....	135
Combining Multiple Pages into Single Page.....	136
How to Print Multiple Pages onto a Single Sheet (When Using the PCL 6 Printer Driver).....	136
Printing on Envelopes.....	138
Configuring Envelope Settings Using the Control Panel.....	138
Printing on Envelopes Using the Printer Driver.....	138
Saving and Printing Using the Document Server.....	139

Storing Documents in Document Server.....	139
Managing Documents Stored in Document Server.....	140
Using the Quick Print Release Function.....	141
Using the Print/Scan(Memory Storage Device) Function.....	143

## 5. Scan

Basic Procedure When Using Scan to Folder.....	147
Creating a Shared Folder on a Computer Running Windows/Confirming a Computer's Information.....	147
Registering an SMB Folder.....	150
Deleting an SMB registered folder.....	154
Entering the Path to the Destination Manually.....	155
Basic Procedure for Sending Scan Files by E-mail.....	156
Registering an E-mail Destination.....	156
Changing or Deleting an E-mail Destination.....	158
Entering an E-mail Address Manually.....	159
Basic Procedure for Storing Scan Files.....	160
Checking a Stored File Selected from the List.....	162
Specifying the File Type.....	164
Specifying Scan Settings.....	165

## 6. Document Server

Storing Data.....	167
Printing Stored Documents.....	170

## 7. Web Image Monitor

Displaying Top Page.....	173
--------------------------	-----

## 8. Adding Paper and Toner





Loading Paper.....	175
Loading Paper into Paper Trays.....	175
Loading Paper into the Bypass Tray.....	178
Loading Orientation-fixed Paper or Two-sided Paper.....	181
Specifying the Paper Setting for the Bypass Tray.....	184
Recommended Paper.....	186
When Loading Thick Paper.....	192
When Loading Envelopes.....	193

Adding Toner.....	196
Faxing/Scanning Operations When Toner Has Run Out.....	198
Disposing of Used Print Cartridge.....	198

## 9. Troubleshooting

When a Status Icon Is Displayed on the Control Panel.....	201
When the Indicator Lamp for [Check Status] Is Lit or Flashing.....	202
When the Machine Makes a Beeping Sound.....	204
When You Have Problems Operating the Machine.....	206
When Multiple Functions Cannot Be Executed Simultaneously.....	212
Messages Displayed When You Use the Copy/Document Server Function.....	213
Messages Displayed When You Use the Fax Function.....	215
Messages Displayed on the Control Panel When You Use the Printer Function.....	225
Messages Printed on the Error Logs or Reports When You Use the Printer Function.....	228
Messages Displayed on the Control Panel When You Use the Scanner Function.....	237
Messages Displayed on the Client Computer When You Use the Scanner Function.....	248
When Other Messages Appear.....	254
Cautions in Removing Jammed Paper.....	262
Removing Jammed Paper.....	268
Locating Jammed Paper.....	269

## 10. Information for This Machine

ENERGY STAR Program.....	271
Energy Saving Functions.....	272
User Information on Electrical and Electronic Equipment  Region <b>A</b> (mainly Europe).....	274
Users in the countries where this symbol shown in this section has been specified in national law on collection and treatment of E-waste.....	274
All Other Users.....	274
For Users in India.....	274
For Turkey Only.....	275
Note for the Battery and/or Accumulator Symbol (For EU countries only)  Region <b>A</b> (mainly Europe).....	276
Environmental Advice for Users  Region <b>A</b> (mainly Europe).....	277
Users in the EU, Switzerland and Norway.....	277
Notes to users in the state of California (Notes to Users in USA)  Region <b>B</b> (mainly North America).....	278

---

Specifications for the Main Unit.....	279
Specifications for the Document Server.....	285
Specifications for Facsimile.....	286
Fax Transmission and Reception.....	286
IP-Fax Transmission and Reception.....	286
Internet Fax Transmission and Reception.....	287
E-mail Transmission and Reception, and Folder Transmission.....	288
Specifications for Printer.....	290
Specifications for Scanner.....	292
Specifications for Lower Paper Tray (250 sheets).....	295
Specifications for Lower Paper Tray (500 sheets).....	296
Specifications for IEEE 1284 Interface Board.....	297
Specifications for Wireless LAN Interface Board.....	298
Specifications for Auto Document Feeder.....	300
Specifications for USB Device Server.....	301
Copyright Information about Installed Applications.....	302
<b>INDEX</b> .....	303

---

# How to Read This Manuals

---

## Symbols Used in This Manuals

---

This manual uses the following symbols:

### **Important**

Indicates points to pay attention to when using functions. This symbol indicates points that may result in the product or service becoming unusable or result in the loss of data if the instructions are not obeyed. Be sure to read these explanations.

### **Note**

Indicates supplementary explanations of the machine's functions, and instructions on resolving user errors.

### **Reference**

Indicates where you can find further relevant information.

[ ]

Indicates the names of keys or buttons on the product or display.

 **Region A** (mainly Europe and Asia), (mainly Europe), or (mainly Asia)

 **Region B** (mainly North America)

Differences in the functions of Region A and Region B models are indicated by two symbols. Read the information indicated by the symbol that corresponds to the region of the model you are using. For details about which symbol corresponds to the model you are using, see page 10 "Model-Specific Information" .



# 1. Getting Started

---

This chapter describes how to start using this machine.

## Names of Major Features

In this manual, major features of the machine are referred to as follows:

- Auto Document Feeder → ADF

## Model-Specific Information

This section explains how you can identify the region your machine belongs to.

There is a label on the rear of the machine, located in the position shown below. The label contains details that identify the region your machine belongs to. Read the label.

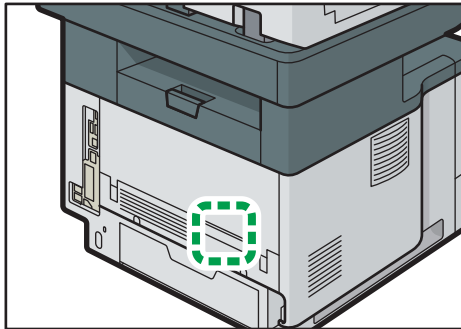

DVL351

The following information is region-specific. Read the information under the symbol that corresponds to the region of your machine.

### Region **A** (mainly Europe and Asia)

If the label contains the following, your machine is a region A model:



- CODE XXXX -27, -29
- 220–240 V

### Region **B** (mainly North America)

If the label contains the following, your machine is a region B model:

- CODE XXXX -17
- 120–127 V

### **Note**

- Dimensions in this manual are given in two units of measure: metric and inch. If your machine is a Region A model, refer to the metric units. If your machine is a Region B model, refer to the inch units.
- If your machine is a region A model and "CODE XXXX -27" is printed on the label, see " Region **A** (mainly Europe)" also.
- If your machine is a region A model and "CODE XXXX -29" is printed on the label, see " Region **A** (mainly Asia)" also.



# Guide to Names and Functions of Components

## Guide to Components

1

### **CAUTION**

- Do not obstruct the machine's vents. Doing so risks fire caused by overheated internal components.

### **Important**

- Do not press or hit the staple unit strongly. Doing so may damage it. If stapling fails after the stapler has been forcefully hit, the staples in the cartridge may be broken.
- Do not hold the staple unit when you move the machine.

## Front and right view

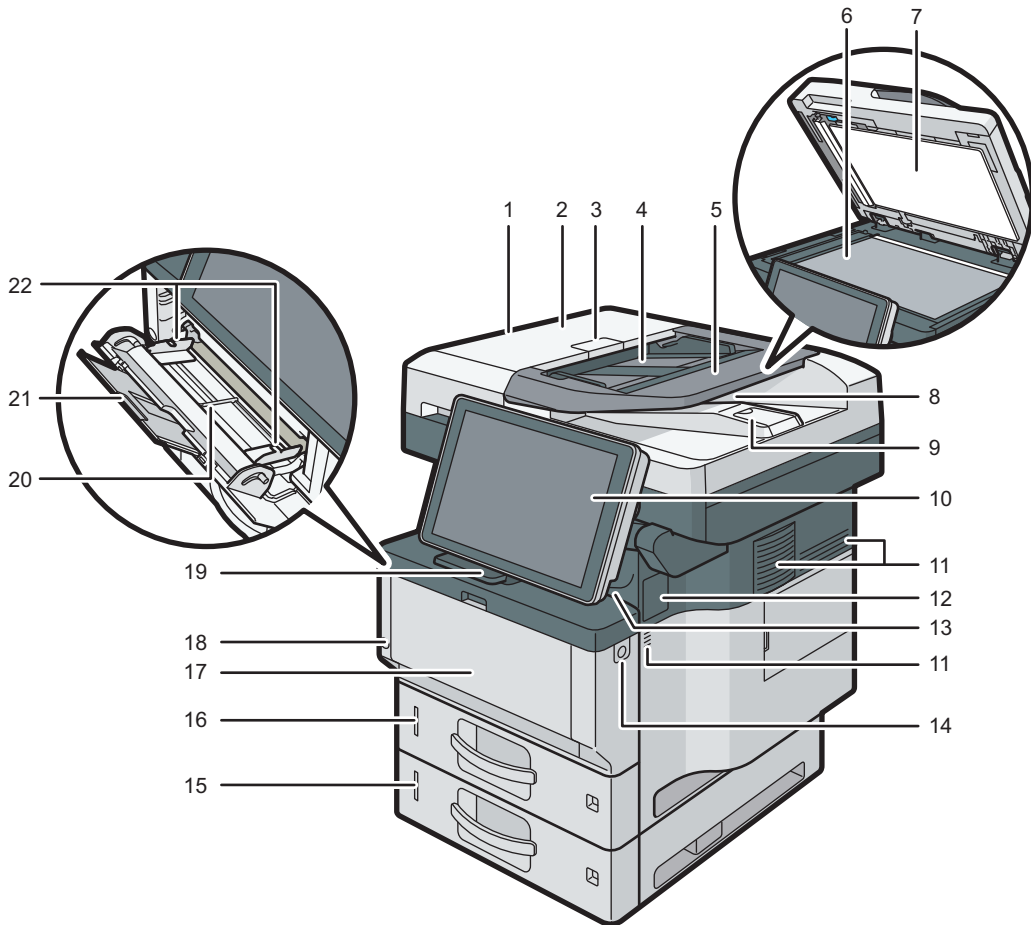

DVL352

### 1. ADF

Lower the ADF over originals placed on the exposure glass.

If you load a stack of originals in the ADF, the ADF will automatically feed the originals one by one.

### 2. ADF cover

Open this cover to remove originals jammed in the ADF.

### 3. ADF cover open lever

Pull this lever to open the ADF cover.

### 4. Input tray for the ADF

Place stacks of originals here.

**5. Extender for the ADF tray**

Extend this when placing paper longer than A4 in the input tray for ADF.

**6. Exposure glass**

Place originals face down here.

**7. Cover for the exposure glass**

Open this cover to place originals on the exposure glass.

**8. Output tray for the ADF**

Originals scanned with the ADF are output here.

**9. Stop fence for the ADF**

Pull out this fence to prevent originals from falling off.

**10. Control panel**

See page 65 "Guide to the Names and Functions of the Machine's Control Panel".

**11. Ventilation holes**

Prevent overheating.

**12. Cover for installing an offline stapler**

Remove when you install the offline stapler.

**13. Internal tray**



Copied/printed paper and fax messages are delivered here.

**14. Front cover open button**

Push this button to open the front cover.

**15. Lower paper tray**

Load paper here.

For details, see page 37 "Guide to Functions of the Machine's External Options  (mainly Europe and Asia)" or page 38 "Guide to Functions of the Machine's External Options  (mainly North America)".

**16. Tray 1**

Load paper here.

**17. Front cover**

Open to access the inside of the machine and remove jammed paper.

Open here to replace the print cartridge and the drum unit.

**18. Main power switch**

To operate the machine, the main power switch must be on. If it is off, turn the switch on.

See page 91 "Turning On/Off the Power".

**19. Stop fence**

Pull this fence to prevent paper from falling off.

**20. Bypass tray**

Use to copy or print on thick paper, OHP transparencies, envelopes, and label paper (adhesive labels).

### 21. Extender for the bypass tray

Pull this extender out when loading A4, 8<sup>1</sup>/<sub>2</sub> × 11 or larger size paper in the bypass tray.

### 22. Paper guides

When loading paper in the bypass tray, align the paper guides flush against the paper.

### Rear and left view

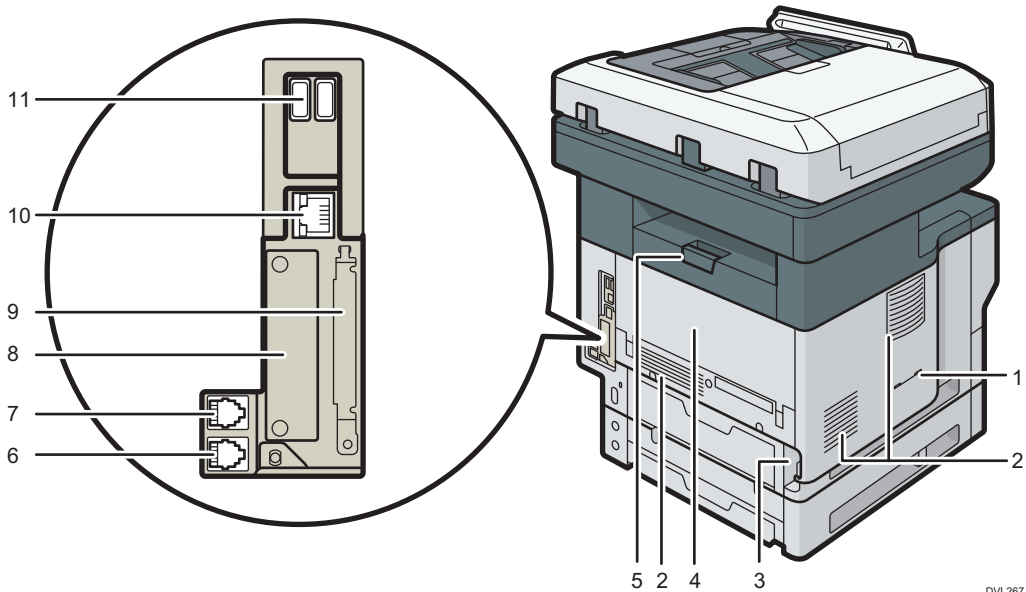

DVL267

#### 1. Handset slit (mainly North America)

Attach the handset bracket to the slit.

#### 2. Vents

Prevent overheating.

#### 3. Power connector

Connect the power cord to the machine. Insert the other end into an electrical outlet.

#### 4. Rear cover

Open to access the inside of the machine and remove jammed paper.

Open here to replace the fusing unit.

#### 5. Rear cover open lever

Pull this lever to open the rear cover.

#### 6. External telephone connector

For connecting an external telephone.

#### 7. G3 interface unit connector

For connecting a telephone line.

**8. Slot**

Optional interface boards can be inserted.

**9. Expansion card slots**

Remove the cover to install SD cards.

**10. Ethernet port**

Use a network interface cable to connect the machine to a network.

**11. USB Host Interface**

Connect external devices such as a card authentication device.

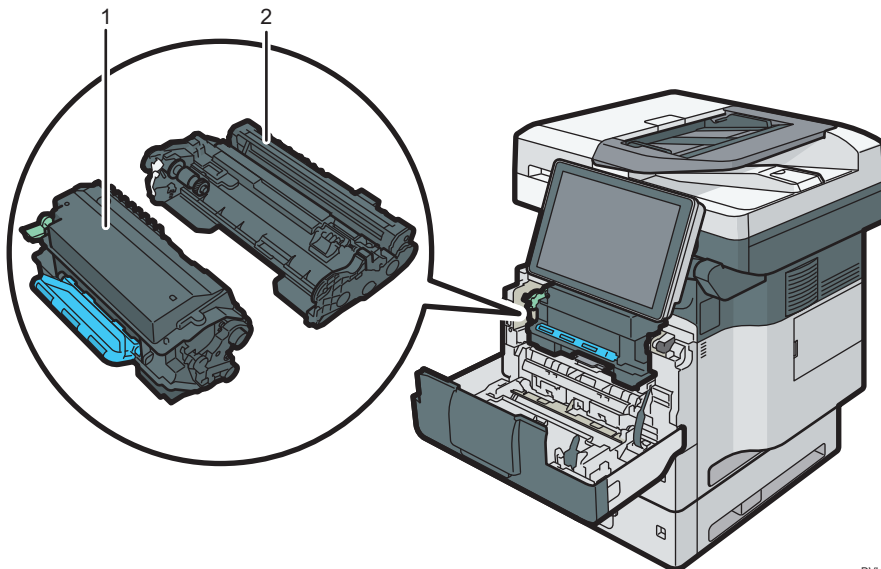
**Interior: Front view**

DVL354

**1. Print cartridge**

To remove jammed paper, pull out the print cartridge and drum unit as a single unit.

Messages appear on the screen when the print cartridge needs to be replaced, or a new cartridge needs to be prepared.

For details about the messages that appear on the screen when consumables need to be replaced, see "Adding Toner", Maintenance.

When you remove jammed paper, pull out the print cartridge with the drum unit. If you want to remove only the print cartridge, pull down the lever on the left side of the print cartridge, and then pull the print cartridge out.

**2. Drum unit**

Messages appear on the screen when the drum unit needs to be replaced, or a new drum unit needs to be prepared.

For details about the messages that appear on the screen when consumables need to be replaced, see "Replacing the Drum Unit", Maintenance.

For IM 350F, IM 350, IM 430F:

When the drum unit needs to be replaced, contact your service representative.

### Interior: Rear view

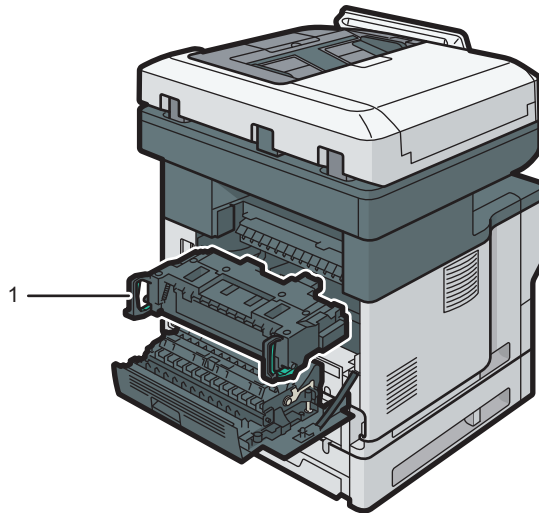

DVL355

#### 1. Fusing unit

Pull out the fusing unit and remove jammed paper.

Messages appear on the screen when the fusing unit needs to be replaced, or a new fusing unit needs to be prepared.

For details about the messages that appear on the screen when consumables need to be replaced, see "Replacing the Maintenance Kit", Maintenance.

For IM 350F, IM 350, IM 430F:

When the fusing unit needs to be replaced, contact your service representative.

### Staple unit

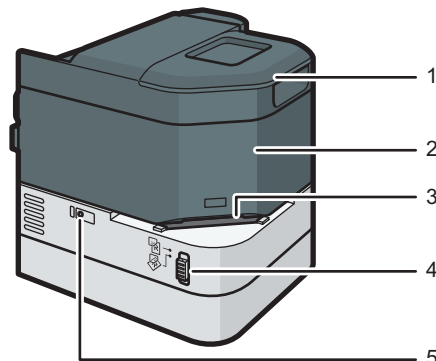

DVL425

#### 1. Staple unit cradle

2. Staple unit
3. Stapling slot
4. Slide switch
5. LED (to indicate there are no more staples)

### Staple cartridge

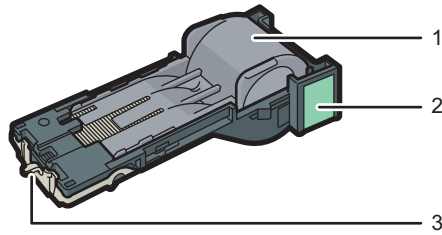

DVL426

1. Staple holder
2. Staple cartridge
3. Faceplate

# Connecting and Setting the Network

## 1

## Setting Wired LAN

### Connecting Ethernet Interface

This section describes how to connect an Ethernet interface cable to the Ethernet port.

If you use an Ethernet interface cable that supports 1000BASE-T, set [Ethernet Speed] to [Auto Select: Enable 1Gbps] in [Interface Settings] in [System Settings].

#### ★ Important

- Use the following Ethernet cables.
    - When using 100BASE-TX/10BASE-T:  
Unshielded Twisted Pair Cable (UTP) or Shielded Twisted Pair Cable (STP) and Category type 5 or more
    - When using 1000BASE-T:  
Unshielded Twisted Pair Cable (UTP) or Shielded Twisted Pair Cable (STP) and Category type 5e or more
  - When you use IPv6, set [Effective Protocol] to [Active] in [Interface Settings] in [System Settings]. IPv6 is inactive as a factory default. When you enable IPv6, a link-local address is automatically set.
  - To use IPv6, consult your network administrator.
1. Make sure the main power is switched off.
  2. Connect the Ethernet interface cable to the Ethernet port.

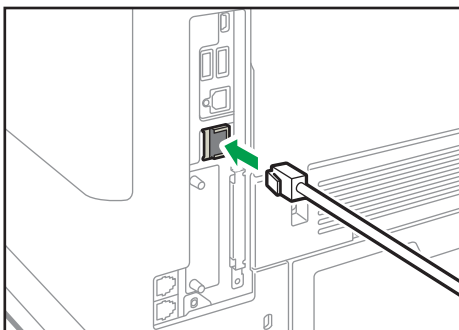

3. Connect the other end of the Ethernet interface cable to a network connection device such as a hub.



#### 4. Turn on the main power switch of the machine.

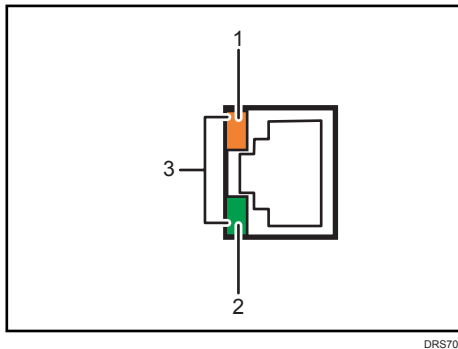

##### 1. Indicator (orange)

When 100BASE-TX is operating, the LED is lit orange.

##### 2. Indicator (green)

When 10BASE-T is operating, the LED is lit green.

##### 3. Indicators (both orange and green)

When 1000BASE-T is operating, both LEDs are lit.

#### Note

- When Energy Saver mode is enabled, the LEDs may not light up.

#### Obtaining an IP address automatically (IPv4 DHCP)

The machine is set to obtain IP addresses automatically as a factory default.

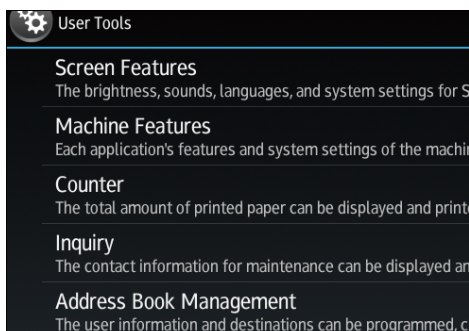

- Press [Home] (🏠) at the bottom of the screen in the center.
- Flick the screen to the left, and then press the [User Tools] icon (⚙️).
- Press [Machine Features].



- Press [System Settings].
- Press [Interface Settings] tab.
- Press [Network].
- Press [Machine IPv4 Address].

8. Press [Auto-Obtain (DHCP)].
9. Press [OK].

### Specifying an IP address (IPv4)

1. Press [Home] () at the bottom of the screen in the center.
2. Flick the screen to the left, and then press the [User Tools] icon ()
3. Press [Machine Features].

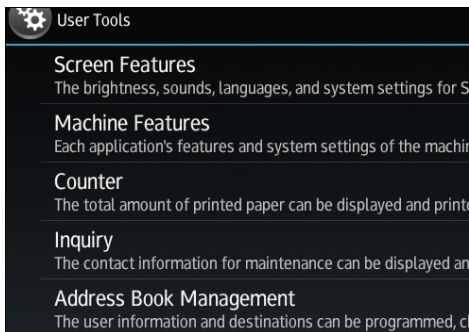

4. Press [System Settings].
5. Press [Interface Settings] tab.
6. Press [Network].
7. Press [Machine IPv4 Address].
8. Press [Specify].
9. Press [Change] next to [Machine IPv4 Address], and then input the IP address.  
When you complete entering the IP address, press [#].
10. Press [OK].
11. Press [Change] next to [Subnet Mask], and then enter the subnet mask.  
When you complete entering the subnet mask, press [#].
12. Press [OK].
13. Press [IPv4 Gateway Address], and then enter the gateway address.
14. Press [OK].

---

## Setting Wireless LAN

---

Wireless LAN connection is available when you install the optional Wireless LAN interface board.

See page 47 "Installing the Wireless LAN interface board" for how to install the Wireless LAN interface board.

## Selecting the communication mode for the Wireless LAN

Select the communication mode according to your environment.

### How to select the mode

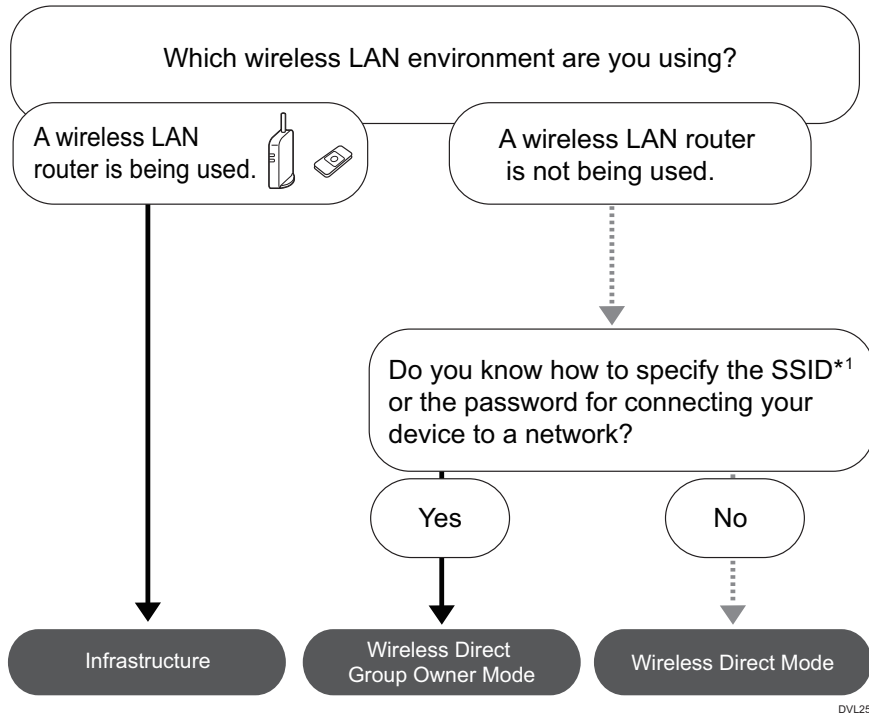

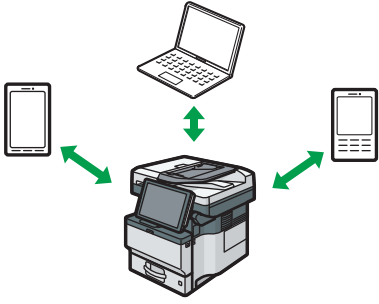
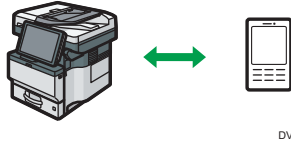
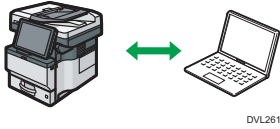
Mode	Description
<p>Wireless Direct Mode</p> <ul style="list-style-type: none"> <li>Wireless Direct Group Owner Mode</li> </ul>  <p>DVL260</p> <ul style="list-style-type: none"> <li>Wireless Direct</li> </ul>  <p>DVK542</p>	<p>In Wireless Direct Mode, you can connect the machine and a device without using a wireless LAN router.</p> <p>There are two types of connection methods in Wireless Direct mode.</p> <ul style="list-style-type: none"> <li>Wireless Direct Group Owner Mode</li> </ul> <p>You can connect several devices, including devices that are not compliant with Wi-Fi Direct. You need to enter the SSID and password of the machine on the device you want to connect.</p> <ul style="list-style-type: none"> <li>Wireless Direct</li> </ul> <p>You can connect the machine and a device directly to each other.</p> <p>Select the machine from the device you want to connect.</p> <p>Only devices that are Android 4.0 or later and support Wi-Fi Direct can be connected.</p> <p>You cannot print data on a network, such as a website, when a device is connected.</p>
<p>Ad-hoc Mode</p>  <p>DVL261</p>	<p>You need to set the ad-hoc channel and other settings, on the device you are connecting.</p> <p>You cannot select WPA2 as the security method. You cannot print data on a network, such as a website, when a device is connected.</p>

### Procedure for the settings

For Ad hoc Mode, see page 23 "Connecting in Ad hoc Mode".

For Infrastructure Mode, see page 24 "Connecting in Infrastructure Mode".

For Direct Connection Mode, see page 26 "Connecting in Direct Connection Mode".

For Direct Connection Group Owner Mode, see page 27 "Connecting in Direct Connection Group Owner Mode".

## Connecting in Ad hoc Mode

In Ad hoc mode, you can specify an SSID to the machine, and connect your computer directly to the machine via a wireless LAN.

### ★ Important

- The Wireless LAN interface board must be installed to use Ad hoc mode.

1. Press [Home] (🏠) at the bottom of the screen in the center.
2. Flick the screen to the left, and then press the [User Tools] icon (⚙️).
3. Press [Machine Features].

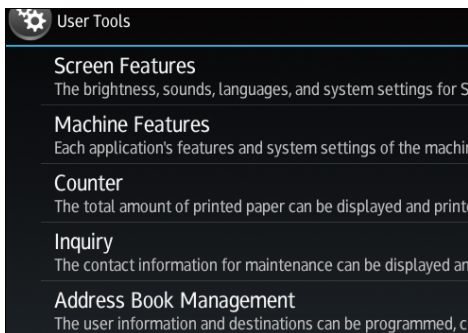

4. Press [System Settings].
5. Press [Interface Settings] tab.
6. Press [Network].
7. Press [LAN Type].
8. Press [Wireless LAN].
9. Press [Wireless LAN].
10. Press [Communication Mode], and then press [802.11 Ad-hoc Mode].
11. Press [OK].
12. Press [SSID Setting].
13. Press [Enter SSID] and enter SSID, and then press [OK].
14. Press [OK].
15. Press [Ad-hoc Channel], and then press the channel to use.
16. Press [OK].
17. Press [Security Method].
18. Press [WEP].
 

To not use security setting, select [No].
19. Press [Enter] in [WEP (Encryption) key].

20. Enter WEP key, and then press [OK].

21. Press [OK].

The settings are complete.

You can connect the device in Ad hoc mode by specifying the SSID, channel, and security method that are specified for the machine.



See the instructions supplied with the device for how to connect it in ad hoc mode.

## Connecting in Infrastructure Mode

Use infrastructure mode to connect the machine to an access point.

### ★ Important

- The Wireless LAN interface board must be installed to use Infrastructure mode.
- When you use IPv6, set Effective Protocol to Active in Interface Settings in System Settings. IPv6 is inactive as a factory default. When you enable IPv6, a link-local address is automatically set.
- To use IPv6, consult your network administrator.

1. Press [Home] () at the bottom of the screen in the center.
2. Flick the screen to the left, and then press the User Tools icon ()
3. Press [Machine Features].

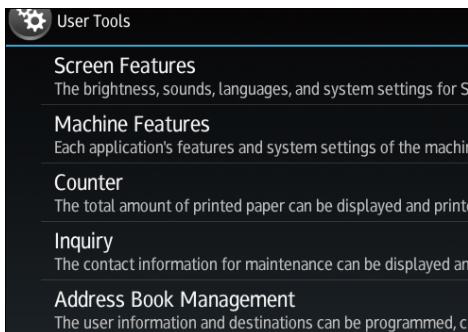

4. Press [System Settings].
5. Press [Interface Settings] tab.
6. Press [Network].
7. Press [LAN Type].
8. Press [Wireless LAN].
9. Press [Wireless LAN].
10. Press [Communication Mode], and then press [Infrastructure Mode].
11. Press [OK].



12. Press [SSID Setting].
13. Press [Enter SSID] and enter the SSID for the access point you want to connect to, and then press [OK].
14. Press [OK].
15. Press [Security Method].
16. Enter the security method that is specified for the access point you want to connect to.  
Press [WEP] or [WPA2], and then press [Enter] on the screen to enter your password.  
If you do not use security setting, select [No].
17. Press [OK].

The settings are complete.

To check the connection status, press [Wireless LAN Signal] in [Wireless LAN] in [Interface Settings] in [System Settings] and confirm the signal status.

### Obtaining an IP address automatically (IPv4 DHCP)

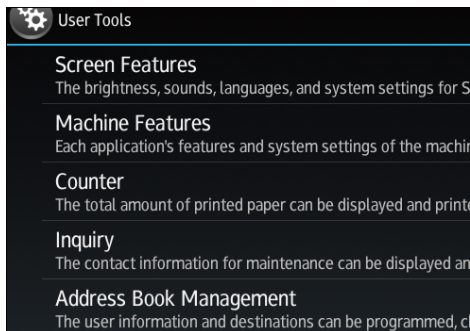

The machine is set to obtain IP addresses automatically as a factory default.

1. Press [Home] () at the bottom of the screen in the center.
2. Flick the screen to the left, and then press the [User Tools] icon ()
3. Press [Machine Features].



4. Press [System Settings].
5. Press [Interface Settings] tab.
6. Press [Network].
7. Press [Machine IPv4 Address].
8. Press [Auto-Obtain (DHCP)].
9. Press [OK].

### Specifying an IP address (IPv4)

1. Press [Home] () at the bottom of the screen in the center.
2. Flick the screen to the left, and then press the [User Tools] icon ()

### 3. Press [Machine Features].

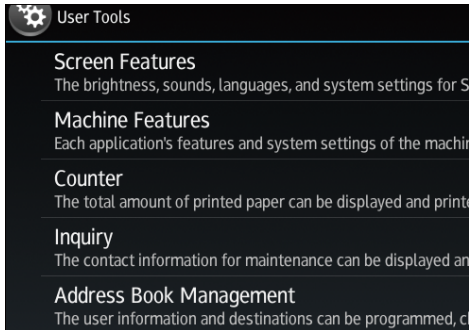

### 4. Press [System Settings].

### 5. Press [Interface Settings] tab.

### 6. Press [Network].

### 7. Press [Machine IPv4 Address].

### 8. Press [Specify].

### 9. Press [Change] next to [Machine IPv4 Address], and then input the IP address.

When you complete entering the IP address, press [#].

### 10. Press [OK].

### 11. Press [Change] next to [Subnet mask], and then enter the subnet mask.

When you complete entering the subnet mask, press [#].

### 12. Press [OK].

### 13. Press [IPv4 Gateway Address], and then enter the gateway address.

### 14. Press [OK].

## Connecting in Direct Connection Mode

To connect another device and the machine directly using the wireless direct function, use the Wireless Direct mode.

### ★ Important

- The Wireless LAN interface board must be installed to use Wireless Direct mode.

1. Press [Home] () at the bottom of the screen in the center.

2. Flick the screen to the left, and then press the [User Tools] icon ()



### 3. Press [Machine Features].

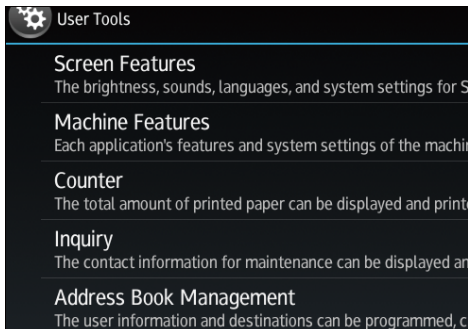

### 4. Press [System Settings].

### 5. Press [Interface Settings] tab.

### 6. Press [Network].

### 7. Press [LAN Type].

### 8. Press [Wireless LAN].

### 9. Press [Wireless LAN].

### 10. Press [Communication Mode], and then press [Direct Connection Mode].

### 11. Press [OK].

### 12. Press [Direct Connection].

### 13. Press [Active/Inactive] and press [Active].

### 14. Press [OK].

### 15. Press [Direct Connection Settings].

### 16. Check [Device Name] and [Connection Password], and then press [OK].

### 17. Press [Wireless LAN].

### 18. Press [Wireless LAN: Easy Setup/Direct Connection].

### 19. Press [Push Button].

### 20. Press [Connect].

The settings are complete.

Operate the push buttons on the device that you want to connect.

See the instructions supplied for the device for how to connect it in Wireless Direct mode.

## Connecting in Direct Connection Group Owner Mode

To connect to multiple wireless direct-compliant devices by using the machine as a simple access point, use the Direct Connection Group Owner mode. Up to nine devices can be connected. Non-wireless direct-compliant devices can be connected too.

### ★ Important

- The Wireless LAN interface board must be installed to use Wireless Direct Group Owner mode.

1. Press [Home] (🏠) at the bottom of the screen in the center.
2. Flick the screen to the left, and then press the User Tools icon (⚙️).
3. Press [Machine Features].

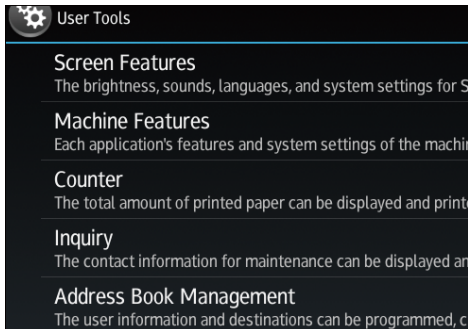

4. Press [System Settings].
5. Press [Interface Settings] tab.
6. Press [Network].
7. Press [LAN Type].
8. Press [Wireless LAN].
9. Press [Wireless LAN].
10. Press [Communication Mode], and then press [Direct Connection: Group Owner Mode].
11. Press [OK].
12. Press [Direct Connection].
13. Press [Active/Inactive] and press [Active].
14. Press [OK].
15. Press [Direct Connection Settings].
16. Check [Device Name] and [Connection Password], and then press [OK].
17. Press [Wireless LAN].
18. Press [Wireless LAN: Easy Setup/Direct Connection].
19. Press [Push Button].
20. Press [Connect].

The settings are complete.

Operate the push buttons on the device that you want to connect.

See the instructions supplied for the device for how to connect it by Wireless Direct mode.

**Note**

- If you specify the SSID and security method in [Wireless LAN] of [Interface Settings] under [System Settings] while the machine is set to Wireless Direct Group Owner mode, the Non-Wireless Direct-compliant devices can access to the machine by specifying the SSID and the security method of the machine.

# Connecting the USB Interface

1

## Connecting to the USB (Type B) Interface

This section describes how to connect a USB 2.0 (Type B) interface cable to the USB 2.0 port on the machine.

This machine does not come with a USB interface cable. Make sure you purchase the appropriate cable for the machine (connector shape) and your computer.

Use a five meter (197 inch) or shorter cable which supports USB2.0 (Type B) interface.

1. **Connect a USB2.0 (Type B) interface cable to the USB2.0 port.**

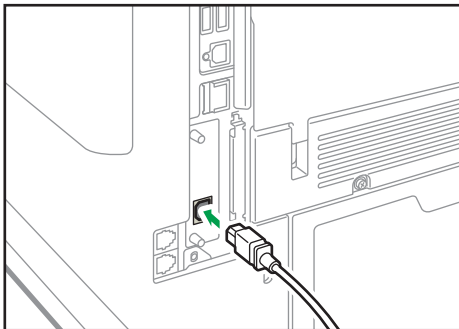

DVL804

## Connecting a Device to the Machine's USB Host Interface

This section explains how to connect a device to the machine's USB host interface.

This machine does not come with a USB interface cable. Make sure you purchase the appropriate cable for the machine (connector shape) and the device.

Use a five meter (197 inch) or shorter cable which supports USB Host Interface.

### **⚠ CAUTION**

- Connect any of the following devices to the USB 2.0 interface: Digital camera, USB keyboards, and IC card readers. Connecting other devices may cause a malfunction.

1. **Connect one end of the USB interface device to the machine's USB host interface.**

If you are using a USB interface cable, connect the other end of it to a device such as card authentication one.

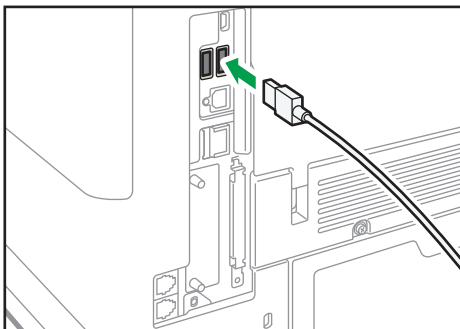

DVL805

# Connecting the Machine to a Telephone Line and Telephone/Handset

## Connecting the Telephone Line Region **A** (mainly Europe and Asia)

To connect the machine to a telephone line, use a snap-in modular type connector.

### Important

- Make sure the connector is the correct type before you start.
- Connect the public switched telephone network (PSTN) to Line. Connecting lines other than PSTN to this machine may cause it to malfunction.

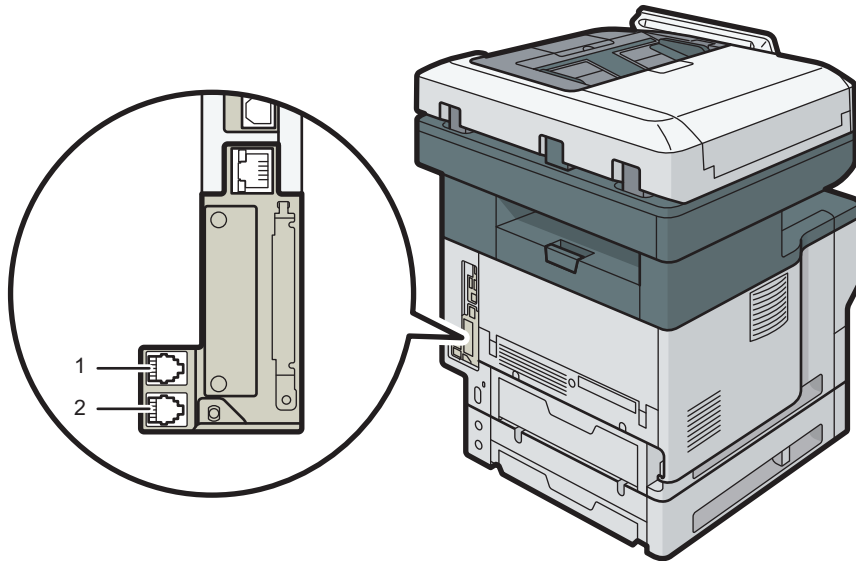

DVL807

### 1. LINE (G3 interface unit connector)

Connect a telephone line.

If you connect a modular cable to the G3 interface unit connector, make two loops 1.5 cm (0.6 inch) (1) from the end of the modular cable (connection side to the machine) and attach the included ferrite core to the loops as shown.

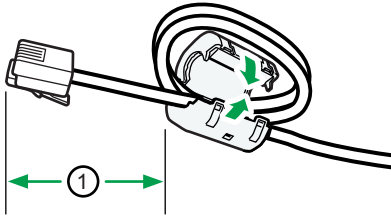

CVC014

## 2. TEL (External telephone connector)

Connect the optional handset or an external telephone.

### ↓ Note

- If a cap has been inserted in the "TEL" connector, remove it before starting to use this connector.

## Connecting the Telephone Line Region **B** (mainly North America)

To connect the machine to a telephone line, use a snap-in modular type connector.

### ⚠ CAUTION

- A telephone line cable with a ferrite core must be used for RF interference suppression.

### ★ Important

- Make sure the connector is the correct type before you start.
- Connect the public switched telephone network (PSTN) to Line. Connecting lines other than PSTN to this machine may cause it to malfunction.

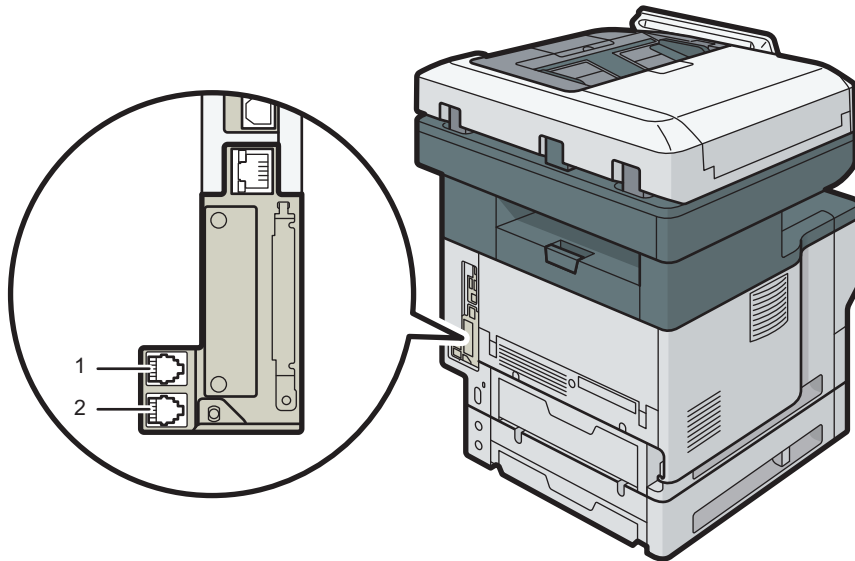

DVL807

**1. G3 interface unit connector**

Connect a telephone line.

**2. External telephone connector**

Connect the optional handset or an external telephone.

**Note**

- If a cap has been inserted in the "TEL" connector, remove it before starting to use this connector.
- Use the supplied modular cable with a ferrite core. Connect the end of the cable with the ferrite core to the machine.

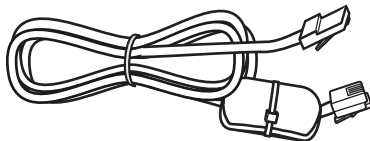

DLN707

---

## Selecting the Line Type

---

Select the line type to which the machine is connected. There are two types: tone and pulse dial.



Select the line type using Administrator Tools.

 **Note**

- This function is not available in some regions.

## Settings Needed for Each Function

The requirements of [Interface Settings] menu items under [System Settings] vary depending on the function or interface environment that you are using. See Network Settings Requirements List and specify the items necessary for the following functions.

- Printer/LAN-Fax
- Internet Fax
- E-mail Function
- Folder Function
- WSD Scanner
- Network TWAIN Scanner
- Document Server

### Important

- **These settings should be made by the administrator, or with the advice of the administrator.**

### Note

- For details about fax settings, see Fax.
- For details about scanner settings, see Scan.

# Guide to Functions of the Machine's External Options Region **A** (mainly Europe and Asia)

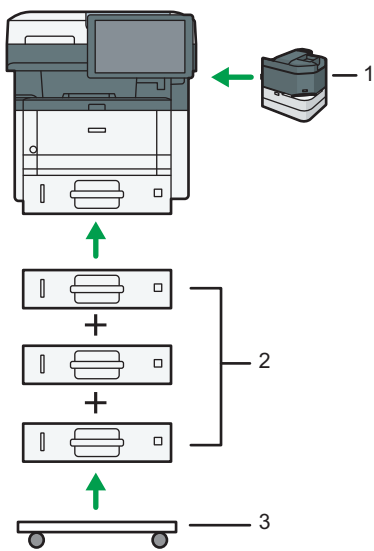

DVL281

## 1. Staple Unit

You can attach the staple unit to stapling the output paper.

## 2. Lower paper trays

You can attach up to three lower paper trays.

There are two types of trays, each holding up to 250 or 500 sheets of paper.

These trays can be used in any combination.

Customer engineer attaches the paper tray depending on the number of the tray. Contact your service representative. For details, see "Attaching the Paper Feed Unit", Setup.

## 3. Caster Table

A table with casters to place this machine.

# Guide to Functions of the Machine's External Options Region **B** (mainly North America)

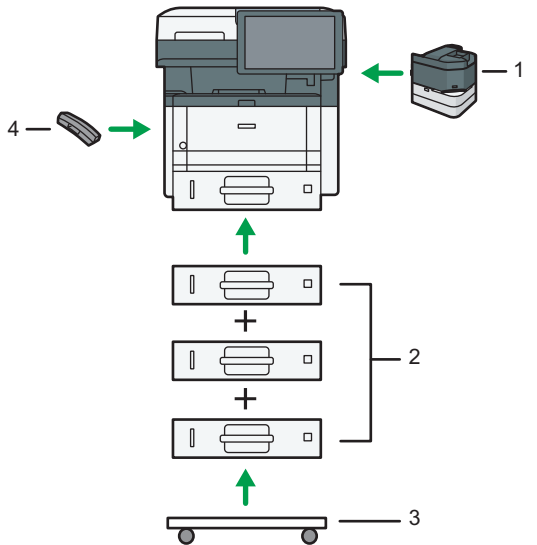

DVL477

## 1. Staple Unit

You can attach the staple unit to stapling the output paper.

## 2. Lower paper trays

You can attach up to three lower paper trays.

There are two types of trays, each holding up to 250 or 500 sheets of paper.

These trays can be used in any combination.

A customer engineer may be required to install this, depending on the number of levels being installed. Contact your authorized service representative. For details, see "Attaching the Paper Feed Unit", Setup.

## 3. Caster Table

A table with casters to place this machine.

## 4. Handset

Used as a receiver.

Allows you to use the On Hook Dial and Manual Dial functions. It also allows you to use the machine as a telephone.

# Order of Option Installation

When installing multiple options, the following order is recommended:

- 1. Attach the Lower paper tray (250 sheets) and the Lower paper tray (500 sheets).**

You can attach up to three paper feed units by any combination.

- 2. Attach the offline stapler.**

- 3. Attach the Handset.**

- 4. Install the interface board.**

Install in the slot of the controller board.

Only one interface board can be installed.

- 5. Insert SD card.**

Insert in the SD card slot of the controller board.

There are two slots for SD cards.

Each slot supports different types of SD cards.

If you want to use two or more SD cards that can be inserted in the same slot, contact your sales or service representative.

# Attaching the Paper Feed Unit

## **⚠ WARNING**

- It is dangerous to handle the power cord plug with wet hands. Doing so could result in electric shock.

## **⚠ CAUTION**

- The machine weighs approximately 30.5 kg (67.3 lb.) (Main unit only, including consumables.)
- When moving the machine, use the inset grips on both sides, and lift slowly in pairs. The machine will break or cause injury if dropped.
- Lifting the paper feed unit carelessly or dropping may cause injury.

## **⚠ CAUTION**

- Unplug the power cord from the wall outlet before you move the machine. While moving the machine, take care that the power cord is not damaged under the machine. Failing to take these precautions could result in fire or electric shock.

## **★ Important**

- Do not place the machine directly on the floor.
- When attaching multiple options, attach the paper feed unit first.
- To attach two paper feed units at the same time, first stack them one upon the other, and then attach them as a single unit.
- Before turning on the power, remove the packaging material from the paper feed unit.

1. Check the contents of the package.
2. Turn the machine off and unplug the power cord.
3. Remove the packaging from the paper feed unit.
4. Lift the machine using the inset grips on both sides of the machine.



DVL102

When moving the machine, do not hold on the following parts as doing so could cause a malfunction:

- The handle onto the standard paper feed tray
- The underside of the bypass tray

5. There are three upright pins on the optional paper feed unit. Align them with the holes on the underside of the machine, and then carefully lower the machine.

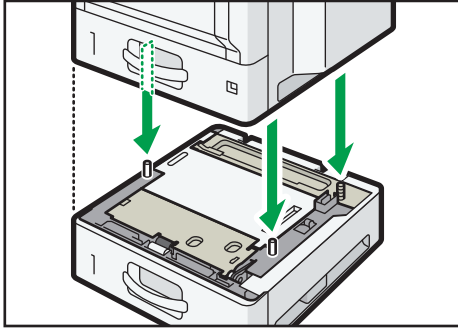





DVL103

6. Plug in the power cord, and then turn on the machine.

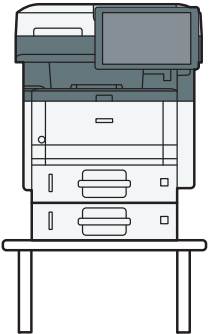
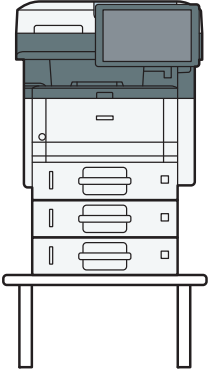
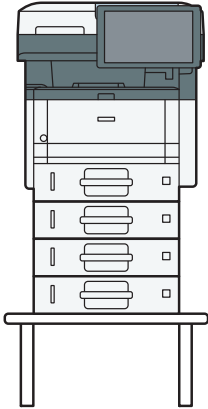
7. Print the configuration page to confirm that the unit was attached correctly.

## The number of tray that you can install

Person who install	Use on table: printer and one or two optional paper feed units		Use on table: printer and three optional paper feed units *1
			

Person who install	Use on table: printer and one or two optional paper feed units	Use on table: printer and three optional paper feed units <sup>*1</sup>
 User	✓	
 Customer engineer	✓	

<sup>\*1</sup> A caster table is required to install three paper feed units on a machine.



# Installing the Offline Stapler

This section describes how to install and use the staple unit.

## ★ Important

- Do not remove the offline stapler after pressing it to fix it to the release paper.
  - Do not press or hit the offline stapler strongly. Doing so may damage it.
  - Do not hold the offline stapler when you move the machine.
1. Turn off the machine's power, and then pull the power plug out of the wall outlet.
  2. By using a coin, open the cover on the right side of the machine.

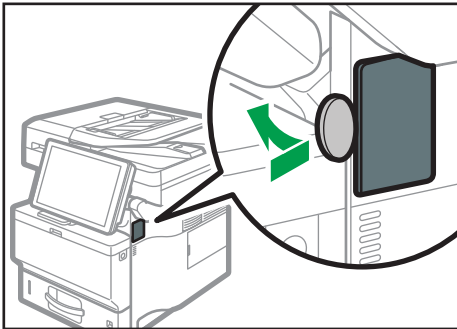

DVK536

3. Take the offline stapler out of the box.

The offline stapler consists of a staple unit and a staple unit cradle. These parts are separate in the box.

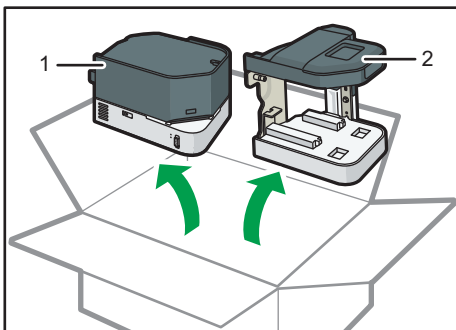

DVL429

1. Staple unit
2. Staple unit cradle

- 4. Fold outside the parts of the release paper that are not stuck to the double-sided tapes on the back of the staple unit cradle.**

The adhesion of the release paper is strong, so it cannot be detached once it is affixed. Do not affix the release paper until Step 7.

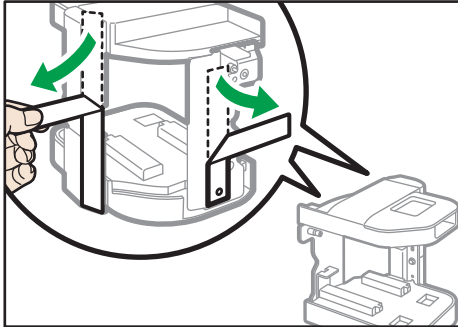

- 5. Align the hole on the staple unit cradle to the bump that is on the right side of the machine, and then insert the screw into the screw hole.**

If the right side of the machine is dirty, clean the surface before mounting the staple unit cradle on the machine.

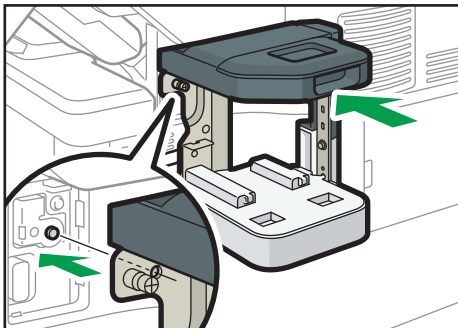

- 6. Align the lines of both the machine and the staple unit cradle as shown in the illustration, and then turn the screw until it stops.**

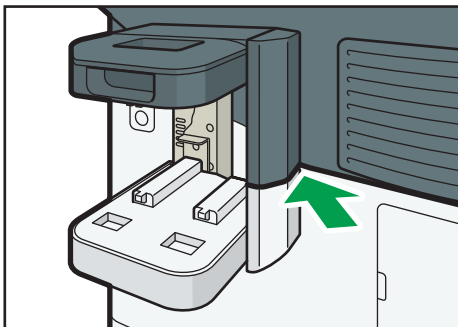

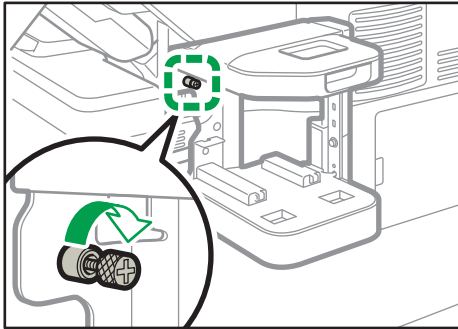

DVL433

- 7. Pull out the pieces of release paper that were folded outside, and then press the staple unit cradle towards the machine.**

Support the staple unit cradle with a hand so that it does not move when pulling out the release paper. Do not press the staple unit forcibly. The release paper may tear. Pull the release paper to the sides slowly.

After removing the release paper, press forcibly on the staple unit cradle to fasten it to the machine.

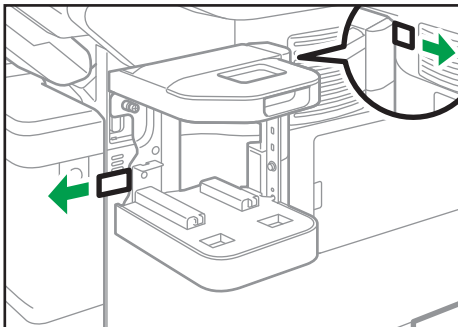

DVL434

- 8. Insert the staple unit into the staple unit cradle.**

Push the staple unit firmly into the back.

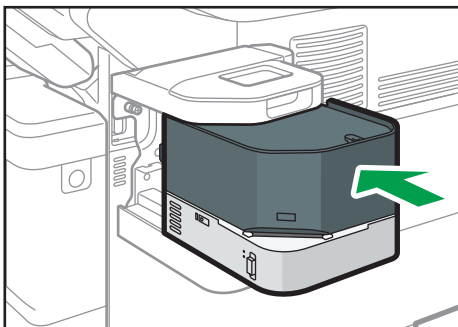

DVL435

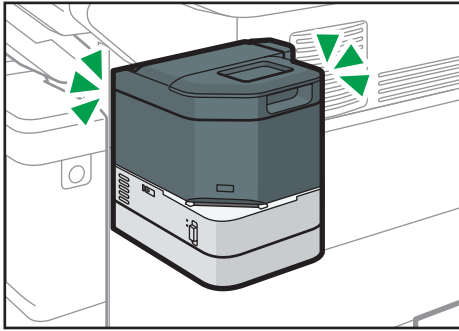

DVL436

**9. Turn the machine's power on.**

The power of the offline stapler also turns on.

# Installing the Wireless LAN interface board

## ★ Important

- Before beginning work, ground yourself by touching something metal to discharge any static electricity. Static electricity can damage the interface units.
- Do not subject the Wireless LAN interface board to physical shocks.

1. Check the contents of the package.
2. Turn the machine off and unplug the power cord.
3. Loosen the two screws and remove the slot cover.

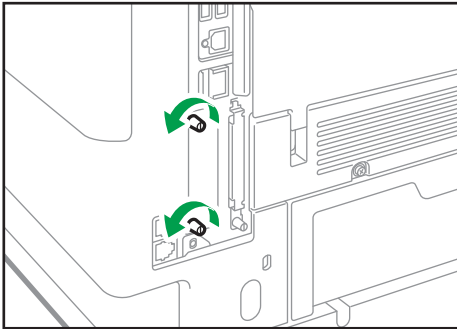

DVL370

The removed cover will not be reused.

4. Fully insert the interface board.

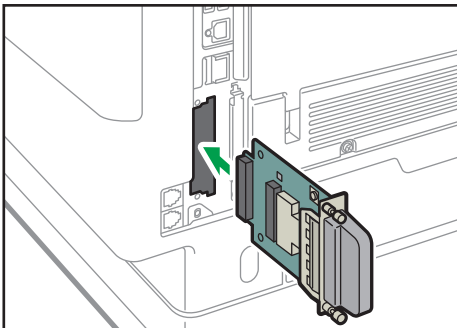

DVL371

Confirm that the interface board is firmly connected to the controller board.

5. Tighten the two screws to secure the interface board.
6. Plug in the power cord, and then turn on the machine.
7. Print the configuration page to confirm that the board was attached correctly.

After installing the Wireless Interface board, see page 20 "Setting Wireless LAN" to specify the wireless LAN settings.

# Installing the IEEE 1284 interface board

## ★ Important

- Before beginning work, ground yourself by touching something metal to discharge any static electricity. Static electricity can damage the interface units.
- Do not subject the IEEE 1284 interface board to physical shocks.

1. Check the contents of the package.
2. Turn the machine off and unplug the power cord.
3. Loosen the two screws and remove the slot cover.

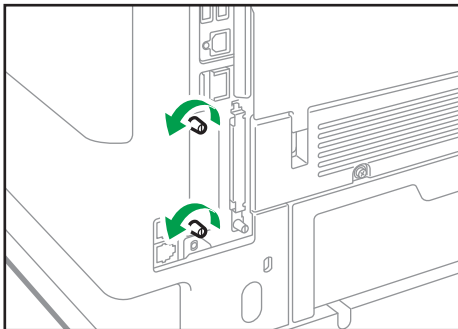

DVL370

The removed cover will not be reused.

4. Fully insert the IEEE 1284 interface board.

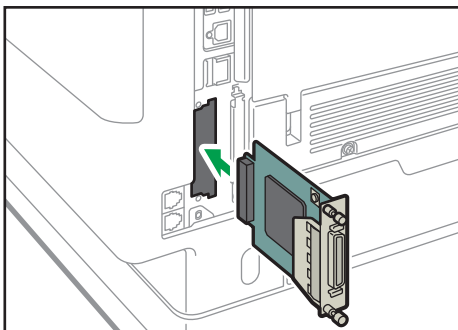

DVL373

Confirm that the IEEE 1284 interface board is firmly connected to the controller board.

5. Tighten the two screws to secure the interface board.
6. Plug in the power cord, and then turn on the machine.
7. Print the configuration page to confirm that the board was attached correctly.

## Connecting to the IEEE 1284 Interface

This section describes how to connect an IEEE 1284 interface cable to the optional IEEE 1284 interface board.

This machine does not come with an IEEE 1284 interface cable. Make sure you purchase the appropriate cable for the machine (connector shape) and your computer.

Use a five meter (197 inch) or shorter IEEE 1284 compatible cable whose performance is guaranteed on the host computer.

1. **Make sure the main power switch on the machine is off.**
2. **Turn off the main power switch of the host computer.**
3. **Connect an IEEE 1284 interface cable to the IEEE 1284 port.**

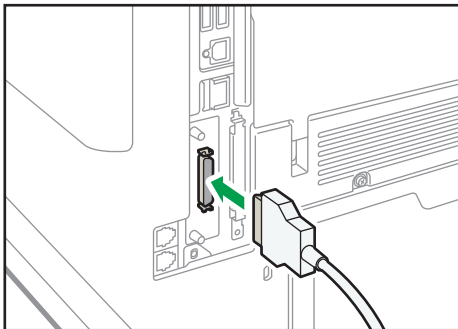

You might have to use a conversion adapter to connect the cable to the interface. For details about acquiring a conversion adapter, consult your sales or service representative.

4. **Connect the other end of the cable into the interface connector on the host computer.**

Before connecting the cable to the computer, check the shape of the connector. Connect the cable firmly.

5. **Turn on the main power switch of the machine.**
6. **Turn on the host computer.**

When using Windows 7/8.1/10 and Windows Server 2008/2008 R2/2012/2012 R2/2016, a printer driver installation screen might appear when the computer is turned on. If this happens, click [Cancel] on the screen.

# Installing the Extended USB board

## ★ Important

- Before beginning work, ground yourself by touching something metal to discharge any static electricity. Static electricity can damage the interface units.
- Do not subject the Extended USB board to physical shocks.

1. Check the contents of the package.
2. Turn the machine off and unplug the power cord.
3. Loosen the two screws and remove the slot cover.

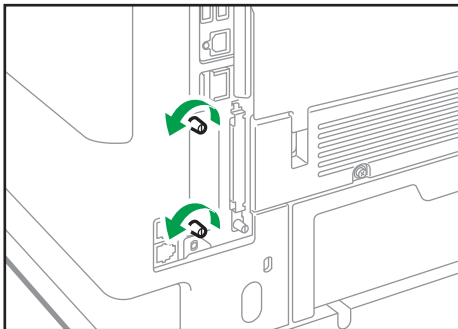

DVL370

The removed cover will not be reused.

4. Fully insert the interface board.

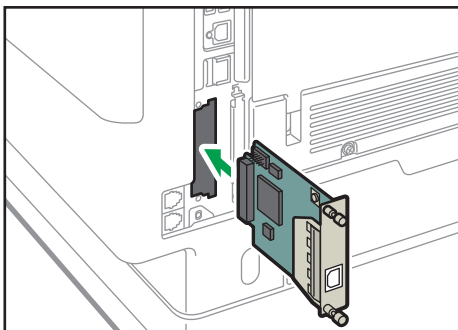

DVL377

Check that the interface board is firmly connected to the controller board.

5. Tighten the two screws to secure the interface board.
6. Plug in the power cord, and then turn on the machine.
7. Print the configuration page to confirm that the board was attached correctly.

See page 30 "Connecting the USB Interface" to connect with USB interface.



# Installing the USB device server

## ★ Important

- Before beginning work, ground yourself by touching something metal to discharge any static electricity. Static electricity can damage the interface units.
- Do not subject the USB device server to physical shocks.

The optional USB device server is an interface board that adds an Ethernet port to the machine.

With this option installed, two Ethernet cables can be connected at the same time using the standard port on the machine and an additional port on the USB device server. You can assign different IP addresses to each port, so the machine can print jobs from different network segments.

## Procedure for installing the USB device server

1. Check the contents of the package.
2. Turn the machine off and unplug the power cord.
3. Loosen the two screws and remove the slot cover.

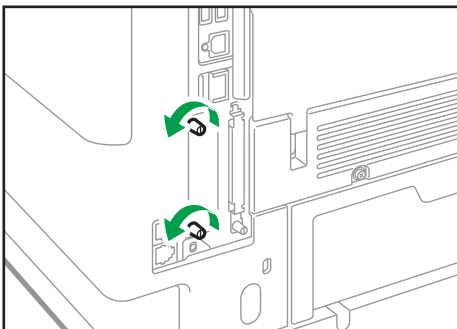

DVL370

The removed cover will not be reused.

4. Fully insert the interface board.

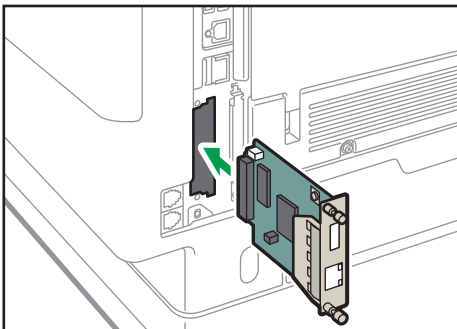

DVL375

Check that the interface board is firmly connected to the controller board.

**5. Tighten the two screws to secure the interface board.**

**6. Connect the USB device server to the machine.**

For details, see the Setup Guide provided with the USB device server.

1

---

## Connecting to the Extra Ethernet Interface with the USB Device Server Option

---

This section describes how to connect an Ethernet interface cable to the Ethernet port of the optional USB Device Server.

USB Device Server Option is an interface board for adding an extra Ethernet port. If you install USB Device Server Option, you can connect two Ethernet cables simultaneously: one to the machine's Ethernet port and one to the Ethernet port of USB Device Server Option. An IP address can be assigned to each connection, and you can use one machine to print from different network segments.

Remove the cover of USB2.0 port on the machine and connect the port to the USB port of the USB device server.

### **CAUTION**

- A network interface cable with a ferrite core must be used for RF interference suppression.

### **Important**

- Use the following Ethernet cables.
  - When using 100BASE-TX/10BASE-T:  
Unshielded Twisted Pair Cable (UTP) or Shielded Twisted Pair Cable (STP) and Category type 5 or more
  - When using 1000BASE-T:  
Unshielded Twisted Pair Cable (UTP) or Shielded Twisted Pair Cable (STP) and Category type 5e or more

**1. Make sure the main power switch is turned off.**

2. Make a loop at a distance of a few centimeters (1) from each end of the Ethernet interface cable, and then attach to each loop the ferrite core provided with the USB Device Server Option.

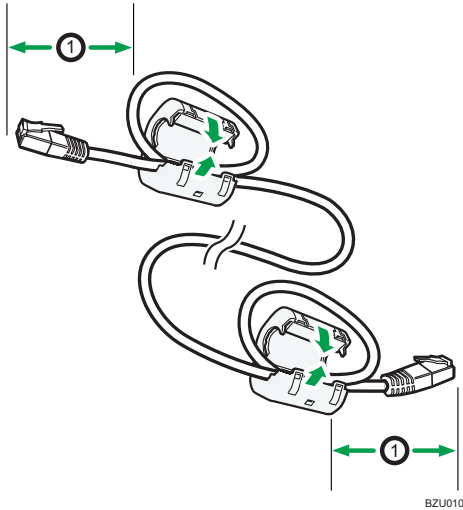

3. Connect the Ethernet interface cable to the Ethernet port of the USB Device Server Option. You can use either a straight or crossover Ethernet cable for connecting to the USB Device Server Option.

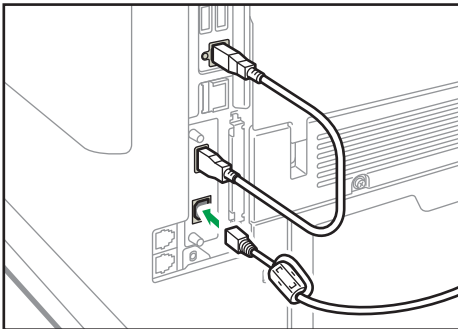

4. Connect the other end of the Ethernet interface cable to a network connection device such as a hub.

It may take several seconds for the machine to recognize the USB Device Server Option. If you have disconnected the USB cable, connect the USB cable again.

**5. Turn on the main power switch of the machine.**

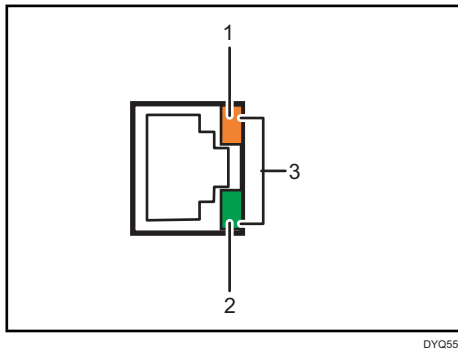

**1. Indicator (orange)**

When 100BASE-TX is operating, the LED is lit orange.

**2. Indicator (green)**

When 10BASE-T is operating, the LED is lit green.

**3. Indicators (both orange and green)**

When 1000BASE-T is operating, both LEDs are lit.

---

## Specifying an IP address for the USB Device Server

---

Specify the IP address for the USB device server manually.

You can share the machine among multiple networks by specifying an IP address of a segment different from that of the machine.

The default network settings of the USB device server are as follows:

- DHCPv4: Disable
- IPv4 address: 192.168.100.100
- Subnet Mask: 255.255.255.0
- Default Gateway: 0.0.0.0
- Network PnP: Enable
- mDNS: Enable
- LAN Interface: Auto
- Primary WINS Server: 0.0.0.0
- Secondary WINS Server: 0.0.0.0

To change the IP address for the USB device server, access the setting screen for the machine using a web browser. For details about the setting items, see the USB device server's Help.

**★ Important**

- To use the USB device server in an IPv6 environment, it is necessary to change the network settings in an IPv4 environment first.
- The machine status does not appear on your computer because the USB device server does not support bidirectional communication.
- You cannot set the IP address for the USB device server using the control panel of the machine.
- The default administrator password is not specified. It is recommended that you specify the administrator password on the [Maintenance Information] screen by using up to seven alphanumeric characters.
- If you forget the IP address of the USB device server or have changed it from its default, follow the procedure below to initialize the USB device server settings:
  1. Turn off the main power of the machine.
  2. Press and hold the switch on the interface using a pointed tool such as a pen, and turn on the machine.

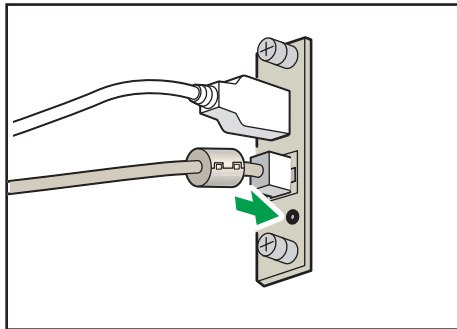

3. Both the upper and lower LEDs of the Ethernet port light up. Be sure to check the upper LED turns off and the lower LED lights up in yellow, and then release the switch.
- Confirm the IP address of your computer before starting setup. The default IP address for the USB device server is "192.168.100.100", and the default subnet mask is "255.255.255.0". To perform the initial setup of the USB device server, set the IP address for your computer to "192.168.100.XXX" (set XXX to any number, other than 100, from 0 to 255), and the subnet mask to "255.255.255.0". It is recommended to make a note of the current IP address before changing it.
1. Enter "http://192.168.100.100/" in the address bar of the Web to access the setting screen of the machine.
  2. Click [Network Settings].
  3. Enter "root" as the user name, and then click [OK].

**4. Specify the IP address, Subnet Mask, and Default Gateway.**

When DHCP is enabled, the IP address can be obtained automatically from a network device with the DHCP server function.

**5. Configure the other settings as necessary, and then click [Submit].**

**6. Exit the web browser.**

**7. Disconnect the Ethernet interface cable from the computer used for setup, and then connect the cable to a network device, such as a hub.**

**8. Set the IP address of the USB device server in the printer driver used for printing.**

**Note**

- The USB device server does not support "Quick Install" and installation using the SmartDeviceMonitor for Client port. A port must be set independently when a printer driver is installed.
- To print using Port 9100 or LPR, see Driver Installation Guide and make the following settings:
  1. Specify the IP address for the USB device server using the "Add Standard TCP/IP Printer Port Wizard".
  2. Select "Custom" for the device type.
  3. For Port 9100, select "Raw" as the protocol, and then specify "9100" for the port number. For LPR, select "LPR" as the protocol, and then specify "lp" as the queue name.
- For IPP printing, see "Using the IPP port", Driver Installation Guide. To specify the URL of the machine during the procedure for adding printers, enter "http://(IP address of the USB device server) /ipp/lp".

# Installing the File Format Converter

## ★ Important

- Before beginning work, ground yourself by touching something metal to discharge any static electricity. Static electricity can damage the interface units.
- Do not subject the File Format Converter to physical shocks.

1. Check the contents of the package.
2. Turn the machine off and unplug the power cord.
3. Loosen the two screws and remove the slot cover.

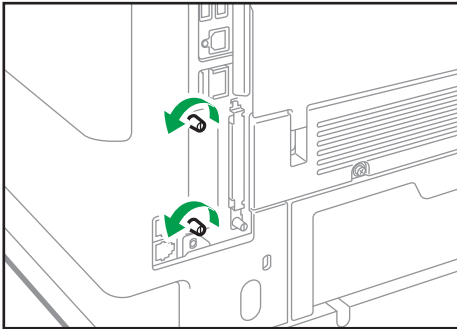

DVL370

The removed cover will not be reused.

4. Fully insert the file format converter.

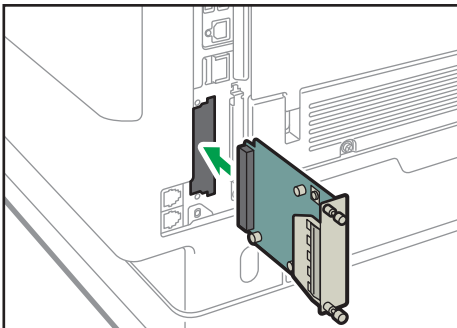

DVL379

Check that the file format converter is firmly connected to the controller board.

5. Tighten two screws to secure the file format converter.
6. Plug in the power cord, and then turn on the machine.
7. Print the configuration page to confirm that the board was attached correctly.

# Installing SD Card Options

## CAUTION

- Keep SD cards out of reach of children. If a child swallows a SD card, consult a doctor immediately.

## Important

- Do not subject the card to physical shocks.
1. Turn the machine off and unplug the power cord.
  2. Loosen the screw and remove the SD card slot cover at an angle.

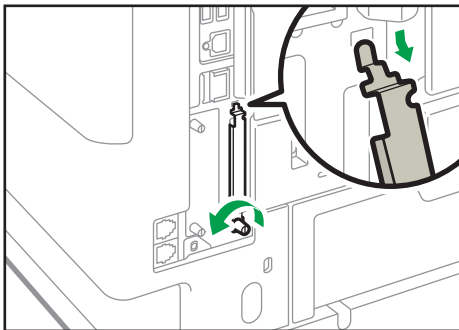

DVL381

3. Insert the SD card into the slot until it clicks.

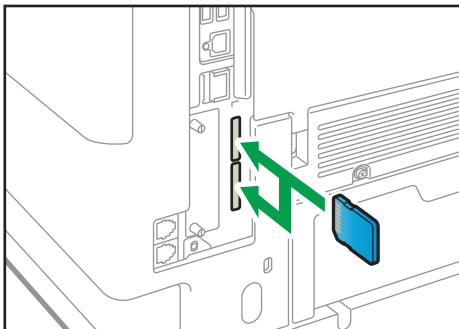

DVL382

If you want to use three or more SD cards simultaneously, contact your service representative.

If you use a commercially available SD card for back up the address book, insert the SD card to lower slot.



- Hook the SD card slot cover onto the opening, attach it flat against the controller board, and then fasten it using the screw.

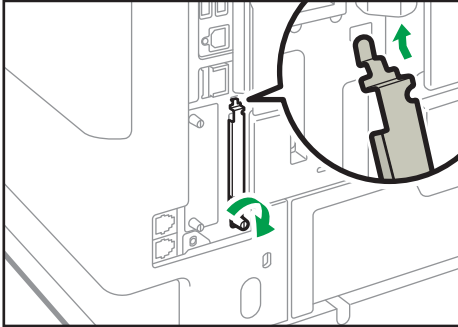

DVL383

- Plug in the power cord, and then turn on the machine.
- Confirm that the SD card was installed correctly.

# Installing the Handset Region **B** (mainly North America)

1

Connecting the handset enables you to use the machine as a telephone and to easily switch the reception mode when a telephone call arrives.

For details about switching the reception mode, see "Fax Reception Modes", Fax.

## ★ Important

- Do not apply strong impact or force to the bracket, or it may be damaged. Maximum force allowable is approx. 50N (approx. 5 kgf). (N = Newton, kgf = Kilogram force. 1 kgf = 9.8N.)
- When you fix the handset cradle to the handset bracket, do not screw it too tightly. Doing so may damage the cradle or bracket.
- A ferrite core is attached to the handset cord to reduce noise. Do not remove the ferrite core.

## Connecting the handset

1. Make sure you have all the following items.

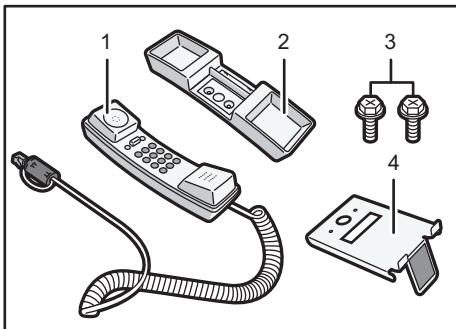

DVL390

1. Handset
2. Handset cradle
3. Screws (2)
4. Handset bracket

**2. Remove the protective tape from the handset bracket.**

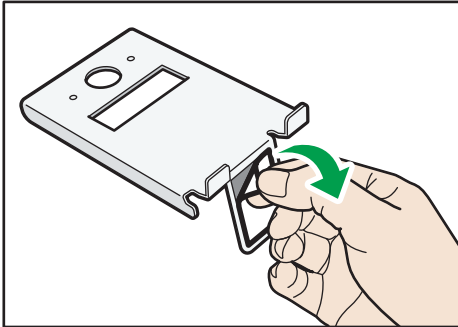

DVL391

**3. Attach the bracket to the left side of the machine, as shown below.**

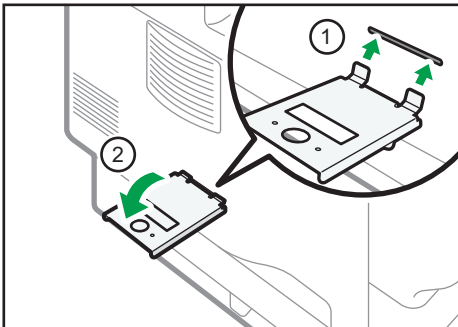

DVL392

**4. Remove the inquiry card from the handset cradle.**

The card can be easily removed by pushing it from the back of the handset.

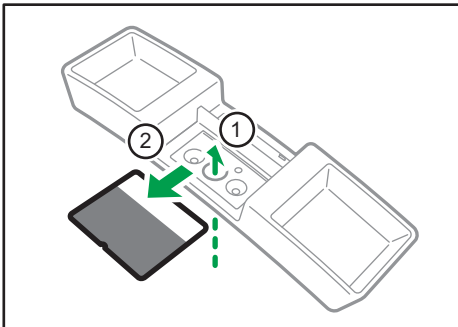

DVL393

5. Fix the handset cradle to the handset bracket by turning the screws with a coin.

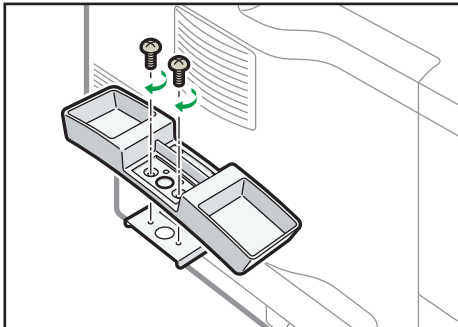

DVL394

6. Place the inquiry card back in the handset cradle.

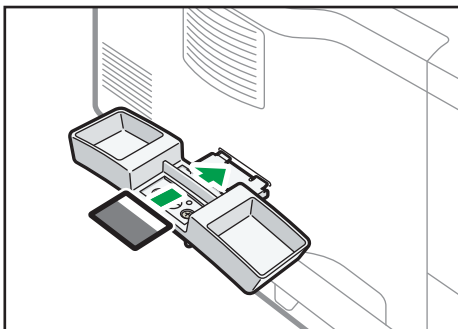

DVL395

7. Place the handset on the handset cradle, and connect the handset cord to the external telephone connector.

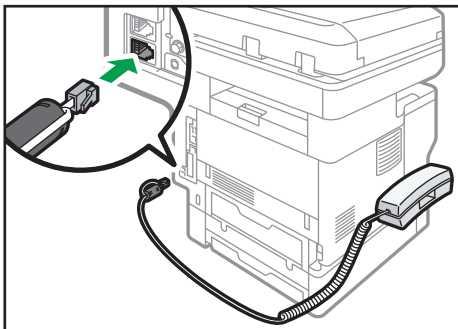

DVL396

## Configuring the handset

---

### Selecting a telephone line type for the handset

With a thin, pointed object, set the switch on the handset to the line type you are using

Push button phone: Push

Dial phone: 10 (PPS)

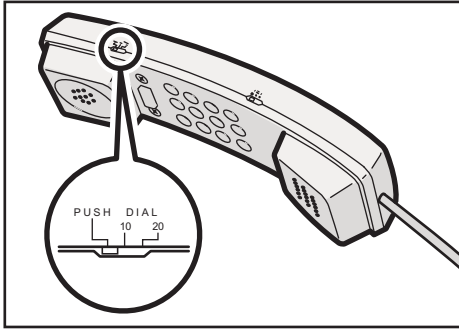

CHP106

### Adjusting the handset bell volume

With a thin, pointed object, adjust the bell volume using the volume switch.

High : H

Low : L

No sound : OFF

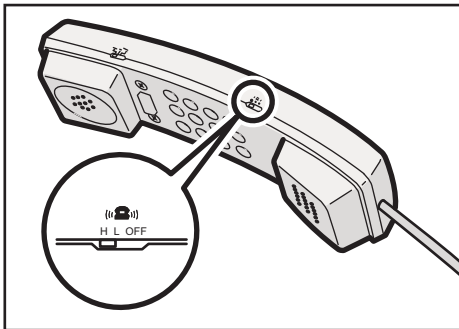

CHP107

---

## Connecting the telephone

---

1. Connect the cord of the telephone to "TEL" connector.

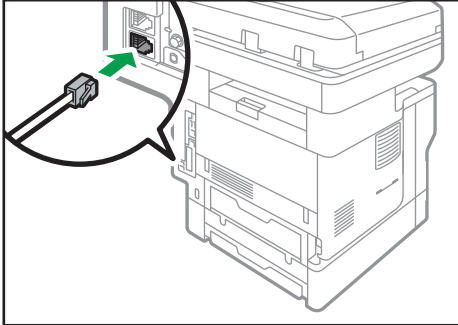

DVK532

# Guide to the Names and Functions of the Machine's Control Panel

1

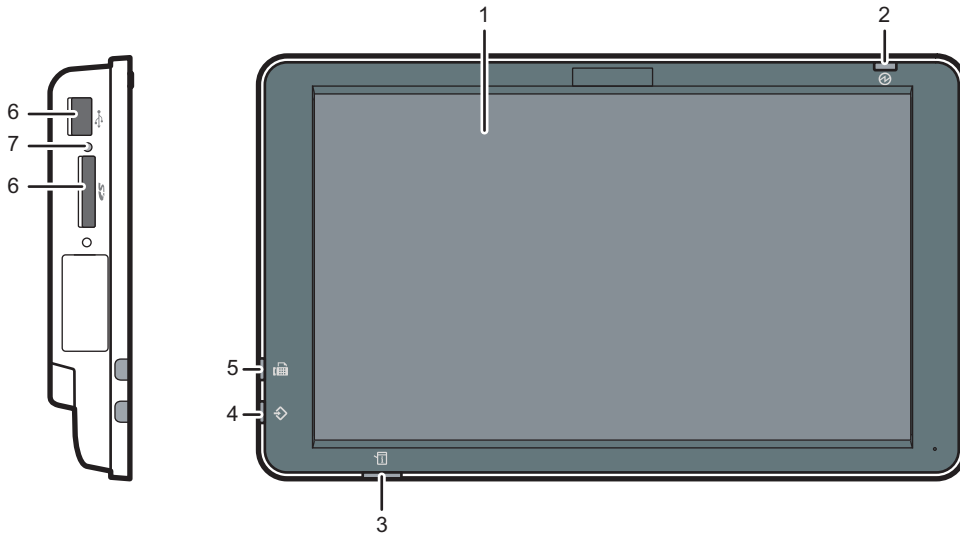

DCH009

## 1. Display panel

This is a touch panel display that features icons, keys, shortcuts, and widgets that allow you to navigate the screens of the various functions and applications and provide you with information about operation status and other messages. See page 67 "How to Use the [Home] Screen" and page 73 "How to Use Each Application".

## 2. Main power indicator

The main power indicator goes on when you turn on the main power switch. When the machine is in Sleep mode, the main power indicator flashes slowly. In Fusing Unit Off mode, the main power indicator is lit.

## 3. Status indicator

Indicates the status of the system. Stays lit when an error occurs or the toner runs out.

## 4. Data In indicator (facsimile and printer mode)

Flashes when the machine is receiving print jobs or LAN-Fax documents from a computer. See Fax and Print.

## 5. Fax indicator

Indicates the status of the fax functions. Flashes during data transmission and reception. Stays lit when receiving a fax via Confidential or Substitute Reception.

## 6. Media slots

Use to insert an SD card or a USB flash memory device. For details, see "Inserting/Removing an SD Card" or "Inserting/Removing USB Flash Memory Device", For First-time Users.

## 7. Media access lamp

Lights up when an SD card is inserted in the media slot. Flashes when the SD card is being accessed.

# Changing the Display Language

1

You can change the language used on the display. English is set as default.

1. Press [Home]  at the bottom of the screen in the center.
2. Flick the screen to the left, and then press the [Change Langs. Widget].
3. Select the language you want to display.
4. Press [OK].

## Note

- You can register display languages. For details about Select Switchable Languages, see "Screen Features", Settings.



# How to Use the [Home] Screen

The [Home] screen is set as the default screen when the machine is turned on.

One icon is assigned to each function, and these icons are displayed on the [Home] screen. You can add shortcuts to frequently used functions or Web pages to the [Home] screen. Also, you can register widgets such as the Change Langs. Widget to it. The [Home] screen and the screen of each function may differ depending on the optional units that are installed.

To display the [Home] screen, press [Home] (🏠) at the bottom of the screen in the center.

## ★ Important

- Do not apply strong impact or force to the screen, or it may be damaged. Maximum force allowable is approx. 30N (approx. 3 kgf). (N = Newton, kgf = Kilogram force. 1 kgf = 9.8N.)

To switch between screens, flick your finger to the right or left on the screen.

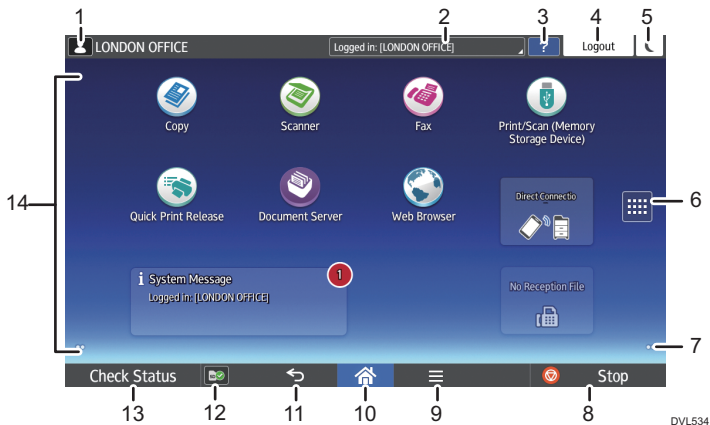

### 1. Logged-in user icon

When user authentication is enabled, an icon is displayed that indicates that users are logged in.

Press the icon to show the names of the users that are currently logged in.

### 2. System message

Displays messages from the machine system and applications.

### 3. [Help]

Displays help for operating the machine.

### 4. [Login]/[Logout]

These keys are displayed when user authentication is enabled. When you press [Login], the authentication screen appears. If you have been already logged in to the machine, [Logout] appears. To log out of the machine, press [Logout].

For details about how to log in and out, see page 93 "Logging In the Machine".

### 5. [Energy Saver] (🌙)

Press to switch to Sleep mode.

For details about the modes, see "Saving Energy", For First-time Users.

## 6. Application list icon

Press to display the application list. You can create shortcuts to the applications on the [Home] screen.

To use an application displayed in the [WIDGET] tab and [PROGRAM] tab, create a shortcut for the application on the [Home] screen. For details, see "Customizing the [Home] Screen", For First-time Users.

## 7. Icons to switch between screens

Press to switch between the five home screens. The icons appear at the bottom right and left of the screen, the number of icons indicates the number of screens on each side of the current screen.

## 8. [Stop]

Press to stop a job in progress, such as copying, scanning, faxing, or printing.

## 9. [Menu]

Displays the menu screen of the application you are using. Depending on the application you are using, this key may be disabled. You can also press this key in the [Home] screen to restore the [Home] screen's settings to their defaults.

## 10. [Home]

Press to display the [Home] screen.

## 11. [Return]

Press this key to return to the previous screen while Screen Features are enabled or applications are used. Depending on the application you are using, this key may be disabled. You can specify whether this key is enabled or not in some applications. For details about the settings, see "Screen Features", Settings.

## 12. [Media Information]

Press to remove the inserted SD card or USB flash memory device from the media slot. For details, see "Inserting/Removing an SD Card" or "Inserting/Removing USB Flash Memory Device", For First-time Users.

## 13. [Check Status]

Press to check the machine's system status, network setting, operational status of each function, and current jobs. You can also display the job history and the machine's maintenance information.

Pressing [Change Settings] in the network status displays network setting menu and allows you to change network setting.

## 14. Icon display area

Displays the function or application icons and widgets. Displayed icons differ between the five home screens. For details about icons on each screen, see "Main Icons on the [Home] Screen", For First-time Users.

You can also add shortcuts and arrange icons using folders. For details, see "Customizing the [Home] Screen", For First-time Users.

### Note

- You can change the [Home] screen's wallpaper. For details, see "Changing the [Home] Screen's Wallpaper", For First-time Users.
- You can switch modes by pressing icons on the [Home] screen. You can also switch modes by pressing the function keys. For details about the function keys, see "Changing Modes by Pressing the Function Keys", For First-time Users.

- You cannot switch modes in any of the following situations:
  - While scanning an original using the fax or scanner function
  - When accessing the following screens:
    - Machine Features
    - Counter
    - Inquiry
    - Address Book Management
    - Tray Paper Settings
    - Current Job / Job History
  - During interrupt copying
  - During On-hook dialing for fax transmission
- The [Home] screen is set as the default screen when the machine is turned on. You can change this default setting under Function Priority. See "Screen Features", Settings.

## Possible Operations on the Standard Application Screen

- Pinch-in

Place your thumb and forefinger on the screen, and then pinch the fingers together to zoom out the screen. Double-tapping can also be effective for this operation.

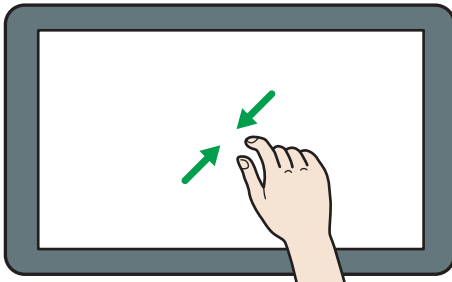

DNE103

- Pinch-out

Place your thumb and forefinger on the screen, and then spread the fingers apart to zoom in the screen. Double-tapping can also be effective for this operation.

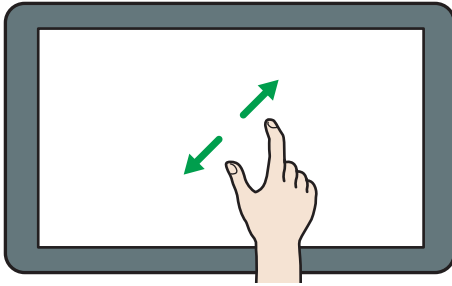

DNE104

- Flick

Flick your finger to the right or left on the screen to switch between screens.

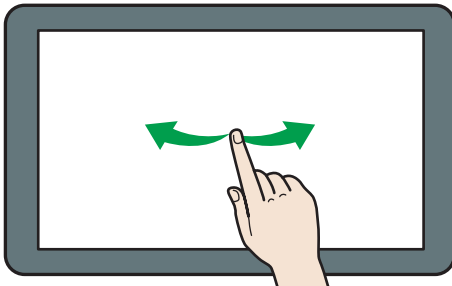

DNE102

- Long tap

Place your finger on the screen and hold it there until the next screen appears. You can display the menu screen of the application you are using.

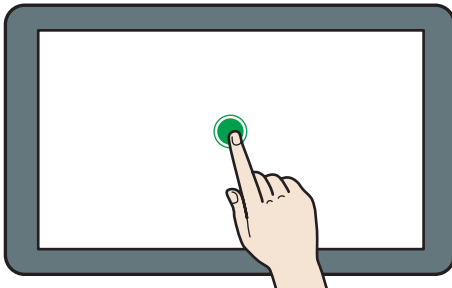

DNE101

- Drag

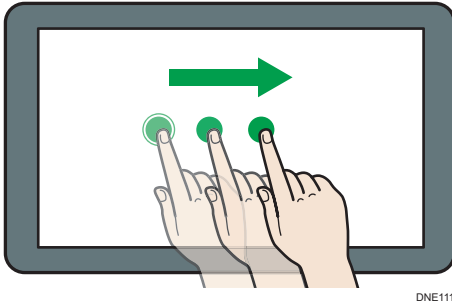

Slide your finger while pressing the screen. You can move an icon to where you want to place it on the screen.



## Adding Shortcuts to the [Home] Screen

You can add shortcuts to the machine's functions.

You can display the icons for the machine's functions and the embedded software applications after you delete them from the [Home] screen.



1. Press [Home]  at the bottom of the screen in the center.
2. Press .
3. Press the [Apps] tab to add a shortcut to an application other than the Classic Applications. Press the [PROGRAM] tab to add a shortcut to one of the Classic Applications.
4. Press and hold down the application icon to add a shortcut to an application other than the Classic Applications. Press and hold down the [Classic Applications] icon to add a shortcut to one of the Classic Applications.

The image of where the shortcut is to be placed on the [Home] screen is displayed.

5. Drag the icon to where you want to place it on the screen.  
If you want to add a shortcut to the Classic Applications, proceed to Step 6.
6. Select the Classic Applications that you want to add from the list.

## Adding Shortcuts to Bookmarks on the [Home] Screen

You can add shortcuts to bookmarks that have been registered in favorites in the Web Browser to the [Home] screen.

1. Press [Home]  at the bottom of the screen in the center.
2. Press .
3. Press the [PROGRAM] tab.
4. Press and hold down the [Bookmark] icon.

The image of where the shortcut is to be placed on the [Home] screen is displayed.



5. Drag the icon to where you want to place it on the screen.
6. Select the bookmark you want to add from the bookmark list.

---

## Adding Shortcuts to Programs to the [Home] Screen

---

You can add shortcuts to programs registered on Copier, Facsimile, Scanner mode, or quick applications.

1. Display the function screen to which you want to register a program.
2. When you are using the standard applications or quick applications, press [Menu] () at the bottom of the screen in the center. When you are using the Classic Applications, press [Recall/Program/Change Program] on the bottom left of the screen.
3. Register a program.
4. Press [Home] () at the bottom of the screen in the center.
5. Press .
6. Press the [PROGRAM] tab.
7. To display a program registered to the standard applications or quick applications, hold down the application icon. To display a program registered to the Classic Applications, hold down the [Classic Applications] icon.

The image of where the shortcut is to be placed on the [Home] screen is displayed.



8. Drag the icon to where you want to place it on the screen.
9. Select the program you want to add from the list.

---

## Adding Widgets to the [Home] Screen

---

You can add widgets to the [Home] screen to show the remaining amount of toner or change the display language.

1. Press [Home] () at the bottom of the screen in the center.
2. Press .
3. Press the [WIDGET] tab.
4. Press and hold down the widget icon you want to add.

The image of where the widget is to be placed on the [Home] screen is displayed.

5. Drag the icon to where you want to place it on the screen.

# How to Use Each Application

You can open the function screens by pressing icons such as [Copy], [Fax], or [Scanner] on the [Home] screen.

Three kinds of screens ("Standard Application Screen", "Classic Application Screen", and "Quick Application Screen") can be used by each function.

## Standard Application Screen

Functions and settings that are used frequently are shown on the top screen. Flick the screen up or down to select a setting item. When you select an item, the pull-down menu appears, or the setting item pops up. For details about operations on this screen, see page 69 "Possible Operations on the Standard Application Screen". For details about how to use the screen, see page 74 "[Copy] (standard) Screen", page 76 "[Fax] (standard) Screen", and page 82 "[Scanner] (standard) Screen".

## Classic Application Screen



You can select advanced functions and detailed settings according to the functions and settings you use frequently. For details about how to use this screen, see "How to Use Each Application", For First-time Users. For details about keys that appear on the screen of each Classic Application, see "Keys that Appear on the Initial Settings Screen and Screens of Each Classic Application", For First-time Users.

## Quick Application Screen

You can easily set the basic operations such as duplex copying, sending scanned documents by e-mail or other operations. For details about how to use this screen, see "How to Use Each Application", For First-time Users.

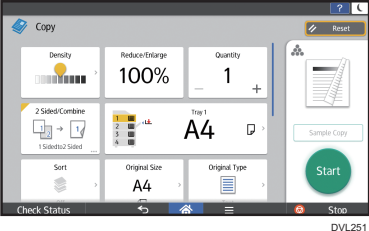
## Functions usable on each screen

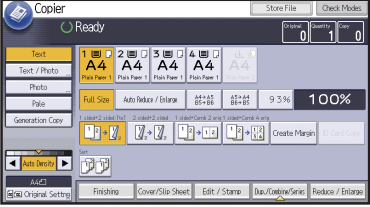
Screen	Functions usable
<p>Standard Application Screen</p> 	<ul style="list-style-type: none"> <li>• Copier</li> <li>• Fax</li> <li>• Scanner</li> </ul>

Screen	Functions usable
<p>Classic Application Screen</p>  <p>DVL252</p>	<ul style="list-style-type: none"> <li>• Copier</li> <li>• Fax</li> <li>• Scanner</li> <li>• Printer</li> <li>• Document Server</li> </ul>
<p>Quick Application Screen</p>  <p>DVL253</p>	<ul style="list-style-type: none"> <li>• Copier</li> <li>• Fax</li> <li>• Scanner</li> </ul>

**Note**

- [Copier (Classic)] icon, [Fax (Classic)] icon, [Scanner (Classic)] icon, and [Printer (Classic)] icon are displayed in the Application list. For details about how to register them to the [Home] screen, see "Customizing the [Home] Screen", For First-time Users.

## [Copy] (standard) Screen

You can switch the two screens described in this section by flicking the screen up or down.

The items on the screen vary depending on the machine's settings.

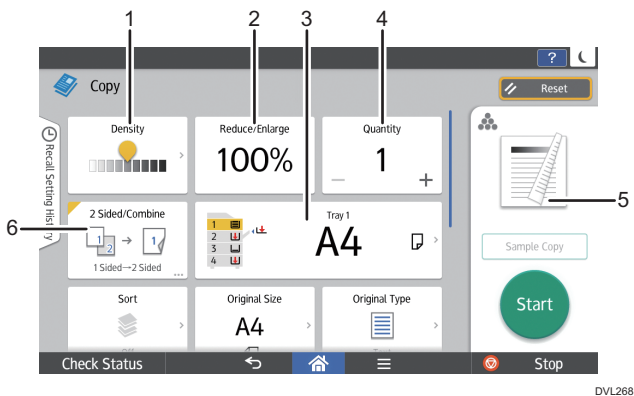



No.	Icon	Description
1		You can adjust the density of the overall original in nine steps. Specify the density by touching the  icon and dragging it right or left.
2	<b>100%</b>	You can reduce or enlarge images.
3	<b>A4</b>	You can specify the paper tray containing the paper you want to copy to.
4	<b>1</b>	You can specify the numbers of copies to be made. Press a number to enter the number of copies using the keyboard. You can also specify the number of copies by pressing [ <b>+</b> ] or [ <b>-</b> ].
5		Preview prints change according to the settings you make.
6		You can combine two 1-sided originals or one 2-sided original to one side of a sheet. The machine selects a reproduction ratio automatically and copies the originals onto a single sheet of copy paper.

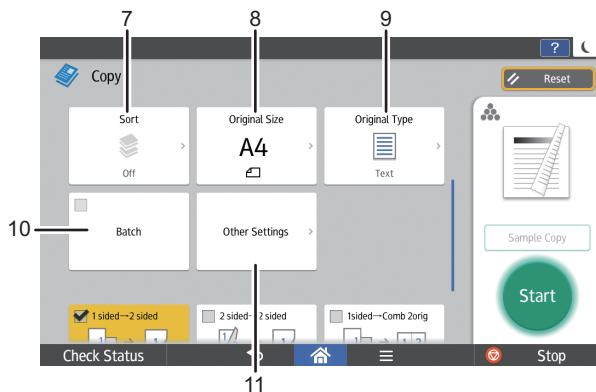



DVL541



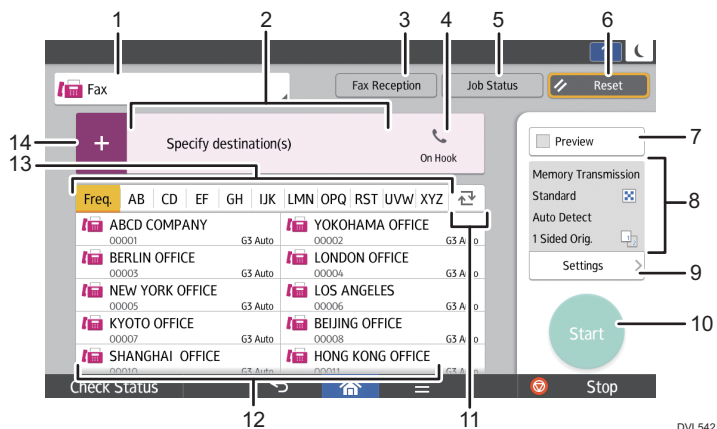

No.	Icon	Description
7		You can sort copies as a set in sequential order and stack copies of each page in a multi-page original.





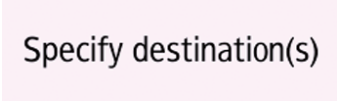

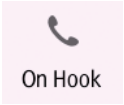
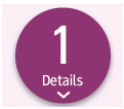

No.	Icon	Description
8	A4	You can specify the size of the original when copying custom size originals.
9		You can select an original type that is suitable for your originals.
10	Batch	You can divide an original that has many pages and scan it in smaller batches while copying it as a single document. To do this, place several pages of the original in the ADF.
11	Other Settings	You can find other settings.

**[Fax] (standard) Screen**

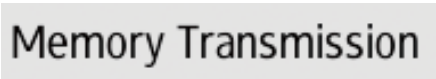

No.	Icon	Description
1	 Fax	You can switch between items in type of transmission.

No.	Icon	Description
2		<p>The specified destination is shown here.</p> <p>By tapping the destination, you can register it to the Address Book or remove it from the destinations.</p> <p>By flicking up and down, you can confirm the selected destinations.</p>
3		<p>You can perform the following operations related to Fax Reception:</p> <ul style="list-style-type: none"> <li>• Check Stored Reception Files</li> <li>• Operate Personal Box</li> <li>• Print ID Required Print Files</li> <li>• Manual Reception</li> <li>• Print Memory Lock</li> <li>• Check Reception File Settings</li> </ul>
4		<p>This function allows you to dial while listening to the dial tone from the internal speaker with the handset of the machine or external telephone on-hook.</p>
		<p>The total number of the selected destinations appears.</p> <p>Press to display a screen to confirm destinations.</p> <p>In the screen to confirm destinations, you can do the following:</p> <ul style="list-style-type: none"> <li>• Register destinations to the Address Book</li> <li>• Edit destinations</li> <li>• Remove destinations from the destination list</li> </ul>
5		<p>You can perform the following operations related to Job Status:</p> <ul style="list-style-type: none"> <li>• Confirm Transmission Standby Files</li> <li>• Check Transmission Results</li> <li>• Check Reception Results</li> <li>• Print Journals</li> </ul>

No.	Icon	Description
6		Press to clear your current settings.
7		Press to display the preview screen after scanning originals.
8		You can check the settings in Settings.
9		Press to open the settings screen. For details, see page 79 "[Settings] screen".
10		Press to scan originals and start sending.
11		Press to switch the section of the Address Book.
12		Shows the destinations in the Address Book.
13		The sections of the Address Book.

No.	Icon	Description
14		<p>Press to add a destination.</p> <p>Destinations can be added as follows:</p> <ul style="list-style-type: none"> <li>• Input destinations manually</li> <li>• Select from the transmission history</li> <li>• Specify a registration number from the Address Book</li> <li>• Search for a destination in the Address Book or on the LDAP server</li> <li>• Press to display the Remaining Memory Information</li> </ul> <p>You can also add a destinations to the Address Book.</p>

### [Settings] screen



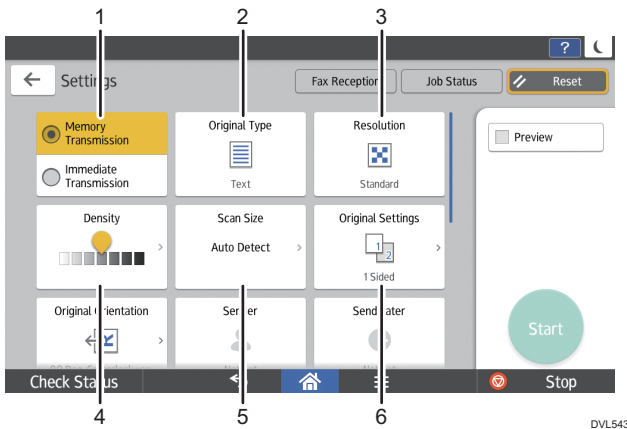

You can switch the three screens described in this section by flicking the screen up or down.

The items on the screen vary depending on the machine's settings.





DVL543

No.	Icon	Description
1		You can switch to immediate transmission mode.

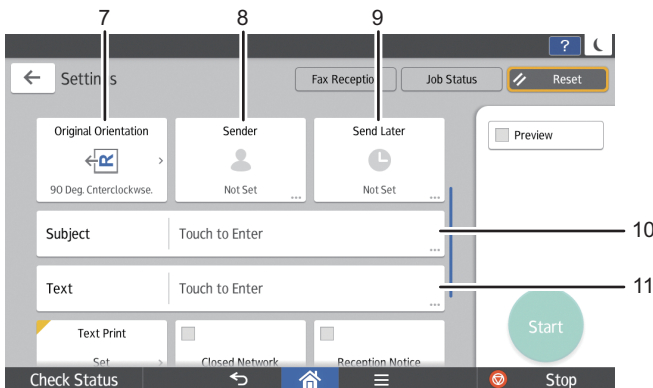
No.	Icon	Description
2	 Text	You can select an original type that is suitable for your originals.
3		Press to select the resolution according to the size of the text on your original.
4		Press to specify the density to scan the original. You can also specify the density by touching the  icon and dragging it right or left.
5	<b>Auto Detect</b>	Press to select the scanning size of the original.
6		Press to select the sides of the original.



DVL544

No.	Icon	Description
7		Press to select the orientation of the original.
8		Press to specify the sender.

No.	Icon	Description
9		You can specify settings to automatically send files directly at a specified time.
10	<b>Subject</b>	Specify the Internet Fax subject.
11	<b>Text</b>	Specify the Internet Fax Text.

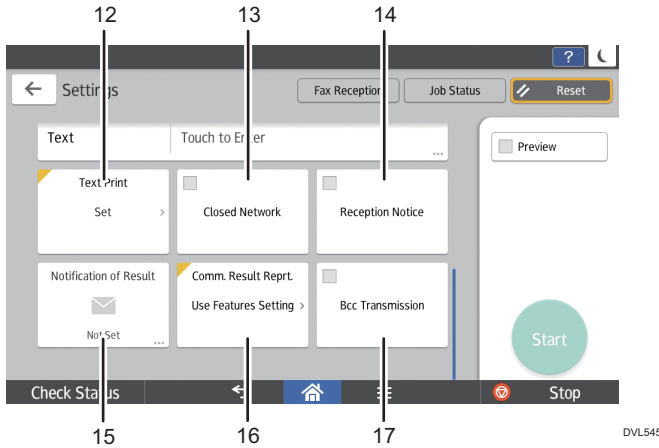



No.	Icon	Description
12	<b>Set</b>	You can select a standard message to be printed.
13	<b>Closed Network</b>	You can send files over a closed network.
14	<b>Reception Notice</b>	Requesting Reception Confirmation.



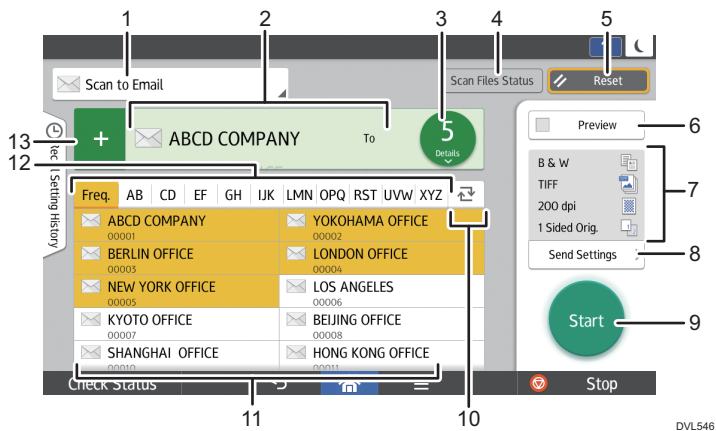

No.	Icon	Description
15		You can receive a transmission notification by e-mail.
16	<b>Use Features Setting</b>	Once memory transmission is complete, you can have the result printed.
17	<b>Bcc Transmission</b>	Specifying Internet Fax Destinations as BCC Addresses.



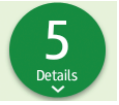
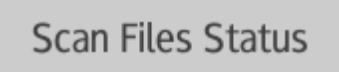

**[Scanner] (standard) Screen**

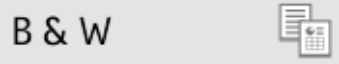

No.	Icon	Description
1		Displays the type of scanner destination. Press to switch between e-mail destinations and folder destinations.
2		The specified destination is shown here. By tapping the destination, you can register it to the Address Book or remove it from the destinations. By flicking up and down, you can confirm the selected destinations.



No.	Icon	Description
3		<p>The total number of the selected destinations appears.</p> <p>Press to display a screen to confirm destinations.</p> <p>In the screen to confirm destinations, you can do the following:</p> <ul style="list-style-type: none"> <li>• Switch the "To", "Cc", and "Bcc" fields of the e-mail destinations</li> <li>• Register destinations to the Address Book</li> <li>• Edit destinations</li> <li>• Remove destinations from the destination list</li> </ul>
4		<p>Press to display the transmission results screen.</p> <p>In the transmission results screen, you can do the following:</p> <ul style="list-style-type: none"> <li>• Check sent jobs</li> <li>• Check error descriptions</li> <li>• Cancel transmission of a document in standby</li> <li>• Print a list of transmission results</li> </ul>
5		<p>Press to clear your current settings.</p>
6		<p>Press to display the preview screen after scanning originals.</p>
7		<p>You can check the settings in Send Settings.</p>
8		<p>Press to open the send settings screen. For details, see page 84 "[Send Settings] screen".</p>
9		<p>Press to scan originals and start sending.</p>

No.	Icon	Description
10		Press to switch the section of the Address Book.
11		Shows the destinations in the Address Book. If a password or protection code is specified to a folder destination, enter the password or protection code on the screen displayed after tapping the folder destination.
12		The sections of the Address Book.
13		Press to add a destination. Destinations can be added as follows: <ul style="list-style-type: none"> <li>• Input destinations manually</li> <li>• Select from the transmission history</li> <li>• Specify a registration number from the Address Book</li> <li>• Search for a destination in the Address Book or on the LDAP server</li> </ul>

### [Send Settings] screen

You can switch the four screens described in this section by flicking the screen up or down.

The items on the screen vary depending on the machine's settings.

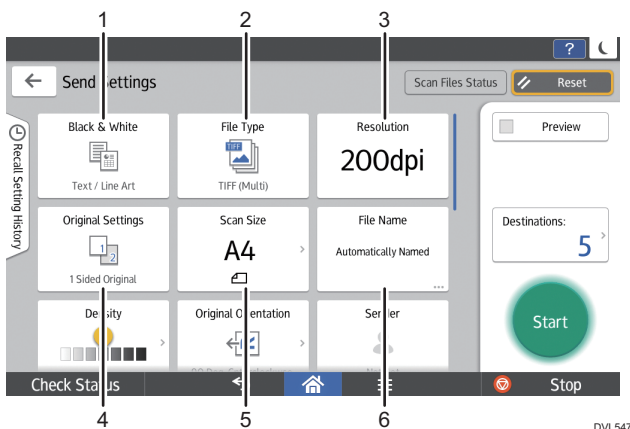

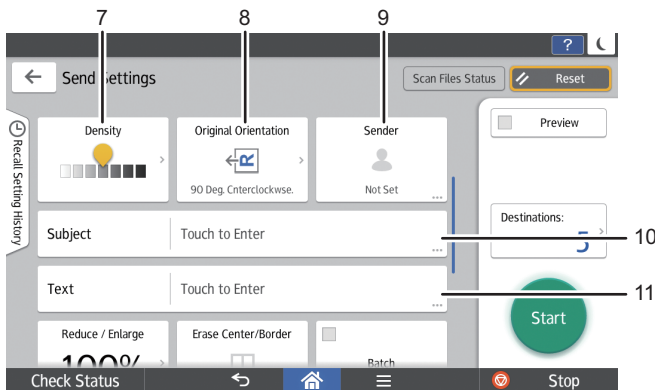

No.	Icon	Description
1		Press to select the settings that are appropriate for the type of your original and color mode.
2		Press to select a file type.
3	200 dpi	Press to select the resolution to scan the original.
4		Press to select the sides of the original to scan, such as one side or both sides.
5	A4	Press to select the scanning size of the original.
6	Automatically Named	Press to specify a file name.



DVL548

No.	Icon	Description
7		Press to specify the density to scan the original. You can also specify the density by touching the  icon and dragging it right or left.

No.	Icon	Description
8		Press to select the orientation of the original.
9		Press to specify the sender.
10	<b>Subject</b>	Press to enter the subject of the e-mail.
11	<b>Text</b>	Press to enter the main text of the e-mail.

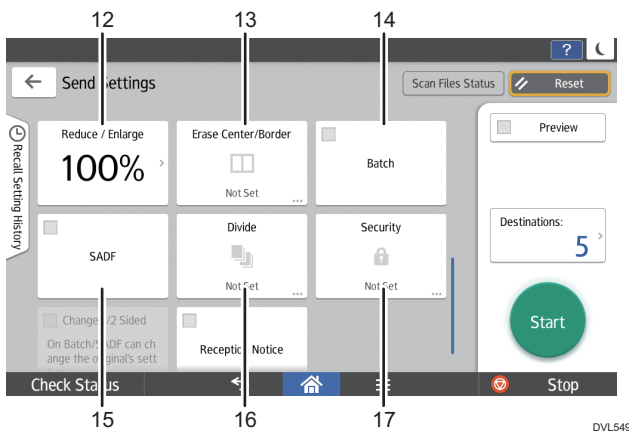

No.	Icon	Description
12	<b>100%</b>	Press to specify the magnification ratio for scanning the original.
13		Press to erase the image from a specified width around the document and in the center of the document when the document is scanned.
14	<b>Batch</b>	Press to scan a large number of originals in several batches and send them together as a single job. You can place multi-page originals in the ADF.

No.	Icon	Description
15	<b>SADF</b>	Press to scan a large number of originals in several batches and send them together as a single job. Place the originals in the ADF one by one.
16		Press to divide a multi-page original into parts of a specified number of pages each, and then send the documents.
17		Press to sign and encrypt the e-mail.

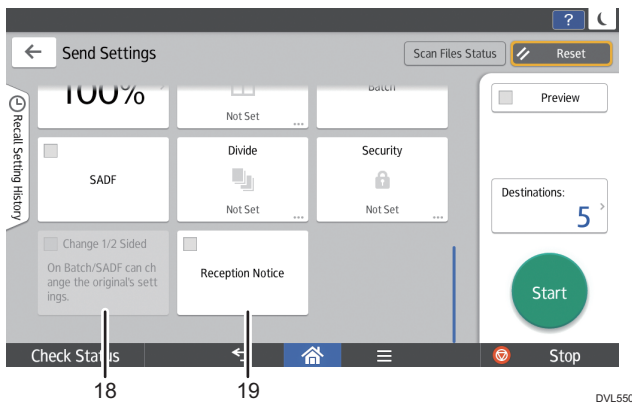

No.	Icon	Description
18	<b>Change 1/2 Sided</b>	To switch the scan setting for additional originals to [1 Sided Original] after scanning one side of the last page of a batch of two-sided originals using the exposure glass, press [Change 1/2 Sided], and then press [1 Sided Original]. You can select this only if [Batch] or [SADF] is also selected.
19	<b>Reception Notice</b>	Press this to notify the sender that the e-mail recipient has opened the e-mail.

# Registering Frequently Used Functions

You can store frequently used job settings in the machine memory and recall them easily.

Depending on the functions, the number of programs that can be registered is different.

## Standard Applications

- Copy: 25 programs
- Fax: 100 programs
- Scanner: 100 programs

## Quick Applications

- Quick Copy: 25 programs
- Quick Fax: 100 programs
- Quick Scanner: 100 programs

The following settings can be registered to programs:

## Standard Applications

- Copy:  
Reduce/Enlarge, Quantity, Density, Paper Tray, 2 Sided, Combine, Sort, Original Size, Original Type, Batch, Other Settings
- Fax:  
Destination, Preview, Settings
- Scanner:  
Destination, Preview, Send Settings

## Quick Applications

- Quick Copy:  
Paper Tray, Quantity, Reduce/Enlarge, 2 Sided, Combine, Original Orientation
- Quick Fax:  
Destination, Line, Density, Resolution, Original Orientation, Original Sides, Scan Size, Original Type, Preview
- Quick Scanner:  
Destination, Original Type, File Type, Resolution, Original Orientation, Original Sides, Scan Size, Preview

This section explains how to register functions to a program by using each application.

## Standard Applications/Quick Applications

1. **Edit the settings so all functions you want to register to a program are selected on the [Copy], [Fax], [Scanner], [Quick Copy], [Quick Fax], or [Quick Scanner] screen.**

2. Press [Menu] (☰) at the bottom of the screen in the center.
3. Press [Reg. Current Setting to Program].
4. Press the program number you want to register.
5. Enter the program name.
6. Select the icon for the program.
7. Press [Prev. Screen].

When using the quick application, press [Back].

8. Press [OK].
9. Press [Place].

Even if you select [Do not Place], you can add shortcuts to the program to the [Home] screen after the program registration is complete.

10. Press [Exit].

#### ↓ Note

- The number of characters you can enter for a program name varies depending on the functions as follows:
  - Standard Applications
    - Copy: 40 characters
    - Fax: 40 characters
    - Scanner: 40 characters
  - Quick Applications
    - Quick Copy: 40 characters
    - Quick Fax: 40 characters
    - Quick Scanner: 40 characters
- When a specified program is registered as the default, its values become the default settings, which are displayed without recalling the program, when modes are cleared or reset, and after the machine is turned on. See "Changing the Default Functions of the Initial Screen", For First-time Users.
- When the paper tray you specified in a program is empty and if there is more than one paper tray with the same size paper in it, the paper tray prioritized under [Paper Tray Priority: Copier] or [Paper Tray Priority: Fax] in the [Tray Paper Settings] tab will be selected first. For details, see "Tray Paper Settings", Settings.
- Destinations can be registered to a program of the scanner mode only when [Include Destinations] is selected for [Program Setting for Destinations] in [Scanner Features]. For details about the setting, see "General Settings", Scan.

- Folder destinations that have protection codes cannot be registered to a program of the scanner mode.
- Programs are not deleted by turning the power off or by pressing [Reset] unless the program is deleted or overwritten.
- When you are using the Classic Applications, program numbers with ↻ next to them indicate that the programs have been registered.
- Programs can be registered to the [Home] screen, and can be recalled easily. For details, see "Sorting/Deleting the Icons on the [Home] Screen", For First-time Users. Shortcuts to programs stored in Document Server mode cannot be registered to the [Home] screen.



# Turning On/Off the Power

## ★ Important

- When you push the main power switch, wait at least 0.5 seconds after it is confirmed that the main power indicator has lit up or gone out.

The main power switch is on the front left side of the machine. When this switch is turned on, the main power turns on and the main power indicator on the right side of the control panel lights up. When this switch is turned off, the main power turns off and the main power indicator on the right side of the control panel goes out. When this is done, machine power is off.

When the fax unit is installed, fax files in memory may be lost if you turn this switch off. Use this switch only when necessary.

This machine automatically enters Fusing Unit Off mode or Sleep mode if you do not use it for a while. For details, see "Saving Energy", For First-time Users.

---

## Turning On/Off the Main Power

---

### CAUTION

- When disconnecting the power cord from the wall outlet, always pull the plug, not the cord. Pulling the cord can damage the power cord. Use of damaged power cords could result in fire or electric shock.

## ★ Important

- Do not turn off the power while the machine is in operation.
- Do not hold down the main power switch while turning off the main power. Doing so forcibly turns off the machine's power and may damage the hard disk or memory and cause malfunctions.
- If a power outage is planned for your work environment, such as turning off the power of your building to do maintenance, turn off the main power in advance. If the power outage occurs while the main power is turned on, it may cause a malfunction.

### Turing on the main power

1. Make sure the power cord is firmly plugged into the wall outlet.
2. Push the main power switch.

The main power indicator goes on.

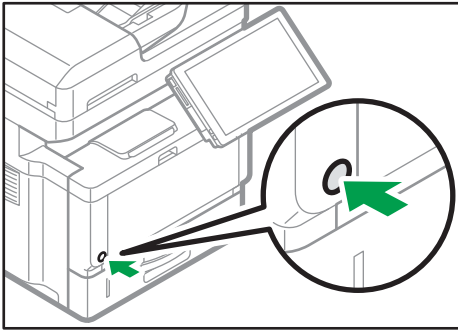

DVL424

### Turning off the main power

#### 1. Push the main power switch.

The main power indicator goes out. The main power turns off automatically when the machine shuts down. If the screen on the control panel does not disappear, contact your service representative.

# Logging In the Machine

To log in to the machine while user authentication is enabled, enter your user name, password, and or user code according to the authentication method.

- Individual Authentication  
If Basic Authentication, Windows Authentication, or LDAP Authentication is enabled, enter the Login User Name and Login Password to log in.
- User Code Authentication  
If User Code Authentication is enabled, enter the User Code to log in.

## ★ Important

- Ask the user administrator for the Login User Name, Login Password, and User Code. For details about user authentication, see "Configuring User Authentication", Security.
- User Code to enter on User Code Authentication is the numerical value registered in the Address Book as "User Code".

## User Code Authentication

If User Code Authentication is active, a screen prompting you to enter a User Code appears.

1. Enter a User Code (up to eight digits), and then press [OK].

! To use the following function(s), enter user code with the Number keys, then press [OK].

Copier

Clear

OK

## Logging In/Out Using the Control Panel

This section explains the procedure for logging in to the machine when Basic Authentication, Windows Authentication, or LDAP Authentication is set.

When User Code Authentication is active, see page 93 "User Code Authentication".

## ★ Important

- To prevent use of the machine by unauthorized persons, always log out when you have finished using the machine.

## Logging In Using the Control Panel

1. Press [Login] on the top right on the screen.

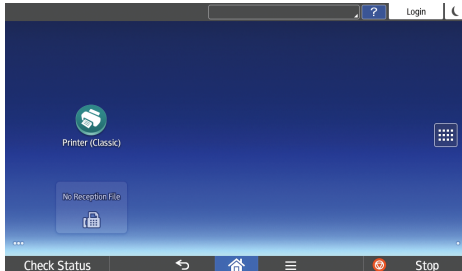

2. Press [User Name].

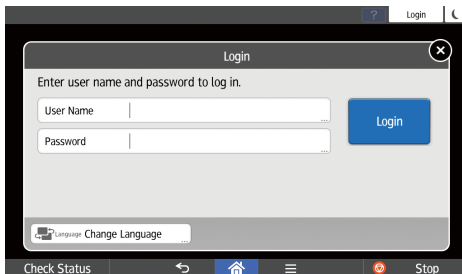

3. Enter a Login User Name, and then press [Done].
4. Press [Password].
5. Enter a Login Password, and then press [Done].
6. Press [Login].

## Logging Out Using the Control Panel

1. Press [Logout] on the top right on the screen.

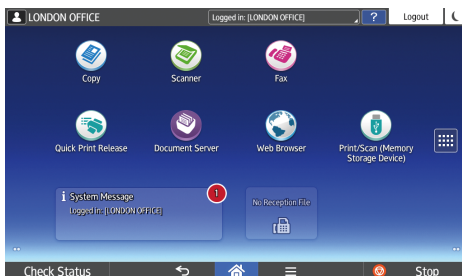

2. Press [OK].

# Placing Originals

## Placing Originals on the Exposure Glass

1

### **⚠ CAUTION**

- Keep your hands away from the hinges and exposure glass when lowering the ADF. Not doing so may result in an injury if your hands or fingers are pinched.

### **★ Important**

- Do not lift the ADF forcefully. Otherwise, the cover of the ADF might open or be damaged.
1. Lift the ADF.
  2. Place the original face down on the exposure glass. The original should be aligned to the positioning mark **A**.

Start with the first page to be scanned.

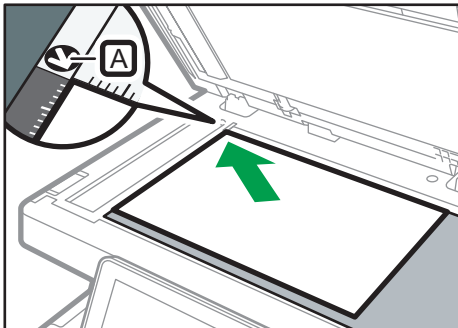

DVL359

3. Lower the ADF.

### **Left original beeper**

The beeper sounds and an error message is displayed when you leave your originals on the exposure glass after scanning.

The machine repeats 5 long beeps four times.

You can change the beeper setting under [Sound of Less Urgent Level] in the Screen Features menu. For details, see "Screen Features", Settings.

## Placing Originals in the Auto Document Feeder

Be sure not to load the original untidily. Doing so may cause the machine to display a paper misfeed message. Also, be sure not to place originals or other objects on the top cover. Doing so may cause a malfunction.

1. Adjust the original guide **B** to the original size.
2. Place the aligned originals squarely face up in the ADF.

Do not stack originals beyond the limit mark **A**.

The first page should be on the top.

When placing originals that are longer than A4  $\square$ ,  $8\frac{1}{2} \times 11$   $\square$ , open the extenders.

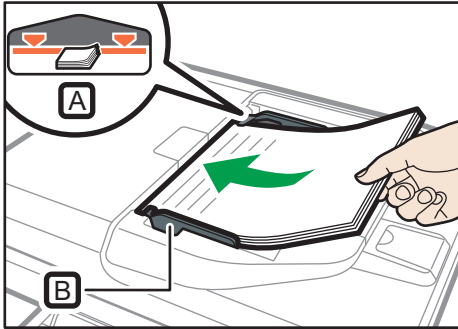

DVL361

## 2. Copy

This chapter describes the basic procedure for making copies.

### Basic Procedure

To make copies of originals, place them on the exposure glass or in the ADF.

When placing the original on the exposure glass, start with the first page to be copied. When placing the original in the ADF, place them so that the first page is on the top.

About placing the original on the exposure glass, see page 95 "Placing Originals on the Exposure Glass".

About placing the original in the ADF, see page 95 "Placing Originals in the Auto Document Feeder".

To copy onto paper other than plain paper, specify the paper type in User Tools according to the type of the paper you are using. For details, see "Tray Paper Settings", Settings.

#### When Using the Copy Application

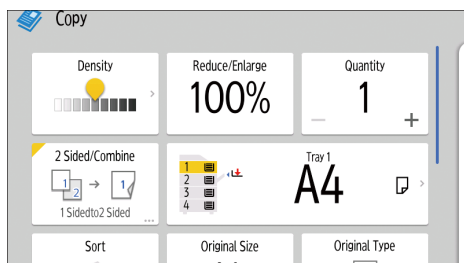

About how to use the application's screen, see page 74 "[Copy] (standard) Screen".

## Auto Reduce / Enlarge

The machine automatically calculates the reproduction ratio based on the sizes of the originals and the paper you have specified. The machine will rotate, enlarge, or reduce the image of the originals to fit them to the paper.

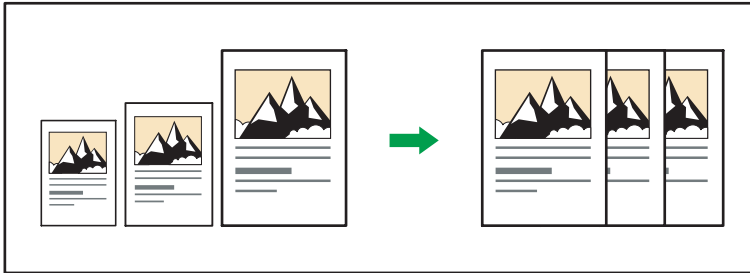

CKN008

### ★ Important

- You cannot use the bypass tray with this function.
- If you select a reproduction ratio after pressing [Auto Reduce / Enlarge], [Auto Reduce / Enlarge] is canceled.

This is useful to copy different size originals to the same size paper.

If the orientation in which your original is placed is different from that of the paper you are copying onto, the machine rotates the original image by 90 degrees and fits it on the copy paper (Rotate Copy). The image is automatically rotated. For details about Rotate Copy, see "Rotate Copy", Copy/ Document Server.

### 📄 When Using the Copy Application

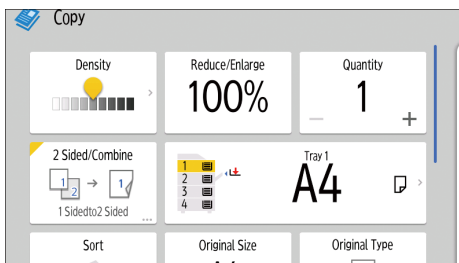

About how to use the application's screen, see page 74 "[Copy] (standard) Screen".



# Duplex Copying

Copies two 1-sided pages or one 2-sided page onto a 2-sided page. During copying, the image is shifted to allow for the binding margin.

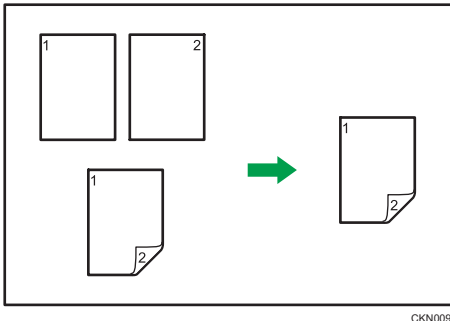

CKN009

There are two types of Duplex.

## 1 Sided → 2 Sided

Copies two 1-sided pages on one 2-sided page.

## 2 Sided → 2 Sided

Copies one 2-sided page on one 2-sided page.

The resulting copy image will differ according to the orientation in which you place your originals (□ or □).

### Original orientation and completed copies

To copy on both sides of the paper, select the original and copy orientation according to how you want the printout to appear.

Original	Placing originals	Original Orientation	Orientation	Copy
			Top to Top	
			Top to Bottom	

Original	Placing originals	Original Orientation	Orientation	Copy
			Top to Top	
			Top to Bottom	

You cannot use the following copy paper with this function:

- Special Paper 2
- Preprinted
- OHP transparencies
- Envelopes
- Letterhead
- Adhesive labels

For details about the sizes, orientations, and weights of paper that can be used in the Duplex function, see "Specifications for the Main Unit", Specifications.

### When Using the Copy Application

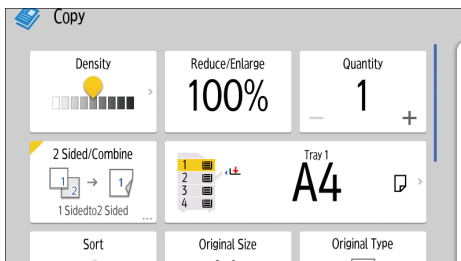

About how to use the application's screen, see page 74 "[Copy] (standard) Screen".

## Specifying the Original and Copy Orientation

Select the orientation of the originals and copies if the original is two-sided or if you want to copy onto both sides of the paper.

- Top to Top

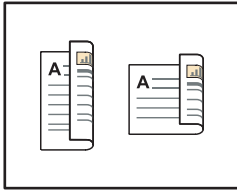

CKN011

- Top to Bottom



CKN012

### When Using the Copy Application

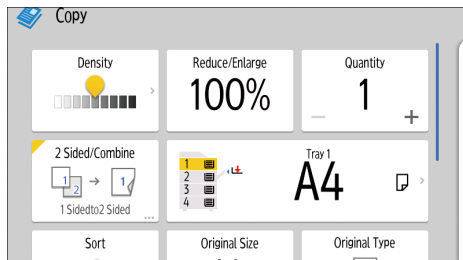

About how to use the application's screen, see page 74 "[Copy] (standard) Screen".

## Combined Copying

This mode can be used to select a reproduction ratio automatically and copy the originals onto a single sheet of copy paper.

The machine selects a reproduction ratio between 25 and 400%. If the orientation of the original is different from that of the copy paper, the machine will automatically rotate the image by 90 degrees to make copies properly.

If you selected [2 Sided] for [Original:] or [Combine 2 Sides] for [Copy], you can change the orientation. For details, see page 100 "Specifying the Original and Copy Orientation".

### Orientation of the original and image position of Combine

The image position of Combine differs according to original orientation and the number of originals to be combined.

- Portrait () originals

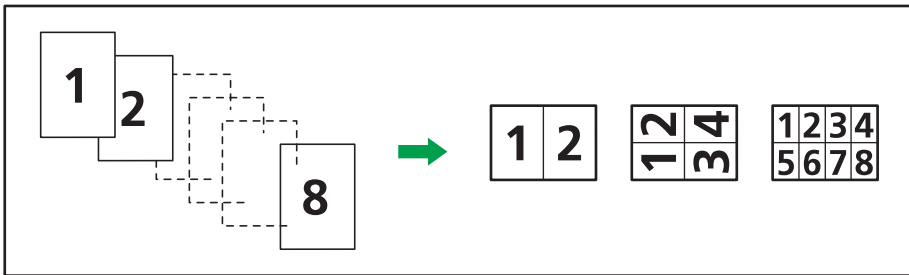

CKN015

- Landscape () originals

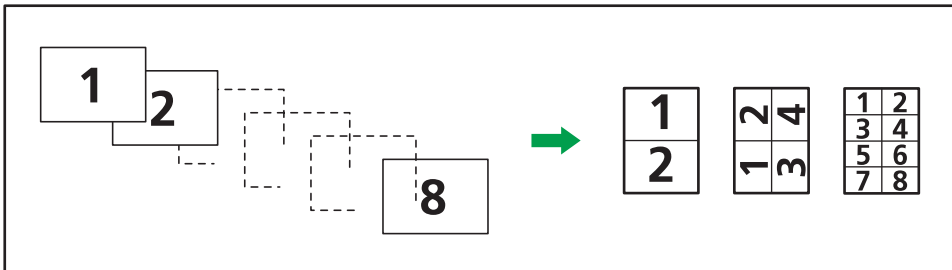

CKN016

### Placing originals (originals placed in the ADF)

The default value for the copy order in the Combine function is [From Left to Right]. To copy originals from right to left in the ADF, place them upside down.

- Originals read from left to right

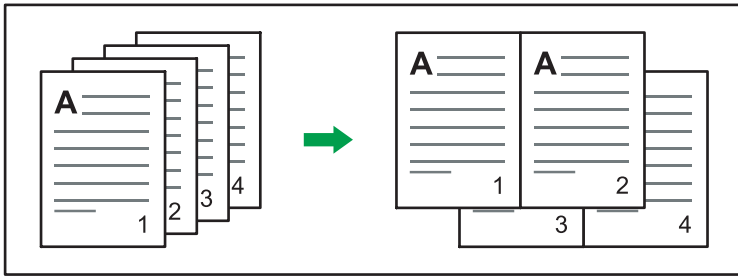

CKN010

- Originals read from right to left

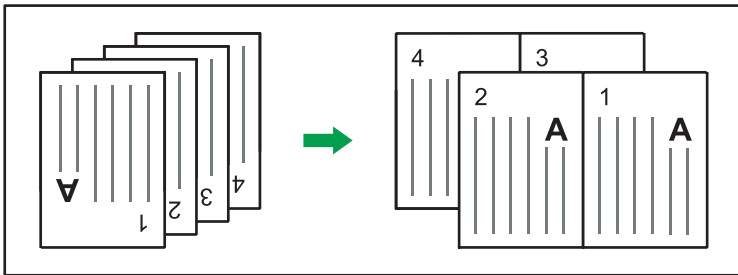

CKN017

## One-Sided Combine

Combine several pages onto one side of a sheet.



CKN014

There are six types of One-Sided Combine.

### 1 Sided 2 Originals → Combine 1 Side

Copies two 1-sided originals to one side of a sheet.

### 1 Sided 4 Originals → Combine 1 Side

Copies four 1-sided originals to one side of a sheet.

### 1 Sided 8 Originals → Combine 1 Side

Copies eight 1-sided originals to one side of a sheet.

### 2 Sided 2 Pages → Combine 1 Side

Copies one 2-sided original to one side of a sheet.

**2 Sided 4 Pages → Combine 1 Side**

Copies two 2-sided originals to one side of a sheet.

**2 Sided 8 Pages → Combine 1 Side**

Copies four 2-sided originals to one side of a sheet.

**When Using the Copy Application**

2

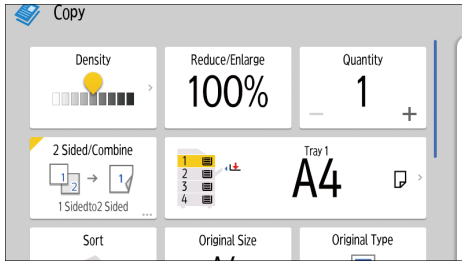

About how to use the application's screen, see page 74 "[Copy] (standard) Screen".

---

## Two-Sided Combine

---

Combines various pages of originals onto two sides of one sheet.

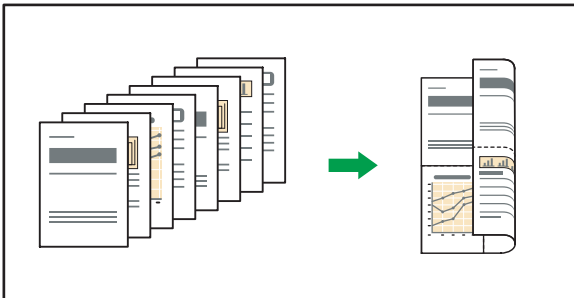

CKN074

There are six types of Two-Sided Combine.

**1 Sided 4 Originals → Combine 2 Sides**

Copies four 1-sided originals to one sheet with 2 pages per side.

**1 Sided 8 Originals → Combine 2 Sides**

Copies eight 1-sided originals to one sheet with 4 pages per side.

**1 Sided 16 Originals → Combine 2 Sides**

Copies 16 1-sided originals to one sheet with 8 pages per side.

**2 Sided 4 Pages → Combine 2 Sides**

Copies two 2-sided originals to one sheet with 2 pages per side.

**2 Sided 8 Pages → Combine 2 Sides**

Copies four 2-sided originals to one sheet with 4 pages per side.

**2 Sided 16 Pages → Combine 2 Sides**

Copies eight 2-sided originals to one sheet with 8 pages per side.

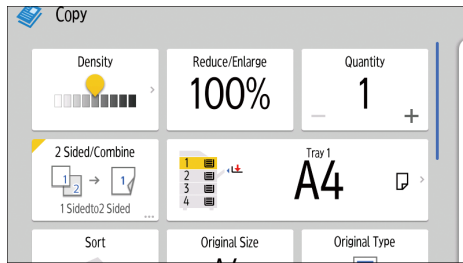

**When Using the Copy Application**

About how to use the application's screen, see page 74 "[Copy] (standard) Screen".

## Copying Onto Custom Size Paper

1. Press [Home]  at the bottom of the screen in the center.
2. Press the [Copier (Classic)] icon.
3. Load the paper face up in the bypass tray.

The bypass tray paper settings screen is automatically displayed.

When [Do not Display] is selected in [Display Paper Settings in Bypass], the bypass tray paper settings screen is not displayed. In this case, make sure that the bypass tray  is selected and press [#]. When [Display Automatically] is selected in [Display Paper Settings in Bypass], even if you press the bypass tray  instead of [#], the bypass tray paper settings screen is displayed. For details, see "General Features", Copy/ Document Server.

4. Confirm the paper type and size, and then press [OK].

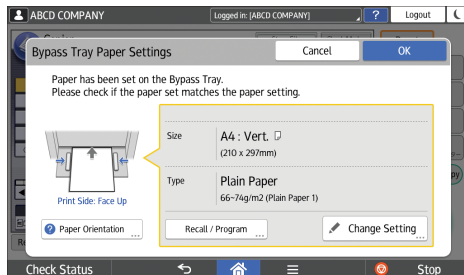

5. Place the originals, and then press [Start].
6. When the copy job is finished, press [Reset] to clear the settings.



# Copying onto Envelopes

This section describes how to copy onto regular size and custom size envelopes. Place the original on the exposure glass and place the envelope in the bypass tray or paper tray.

Specify the thickness of the paper according to the weight of the envelopes you are printing on. For details about the relationship between paper weight and paper thickness and the sizes of envelopes that can be used, see "Recommended Paper", Specifications.

About handling envelopes, supported envelope types, and how to load envelopes, see "Recommended Paper"- "When Loading Envelopes", Specifications.

## ★ Important

- The Duplex function cannot be used with envelopes. If the Duplex function is specified, press [1 sided → 2 sided:TtoT] to cancel the setting.

## 📄 When Using the Copy Application

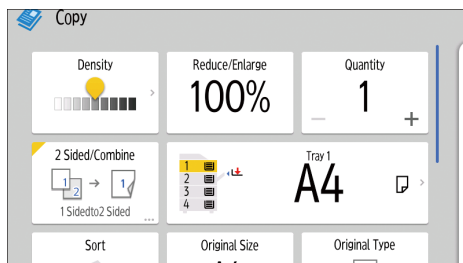

About how to use the application's screen, see page 74 "[Copy] (standard) Screen".

# Sort

The machine assembles copies as sets in sequential order.



CKN018

## When Using the Copy Application

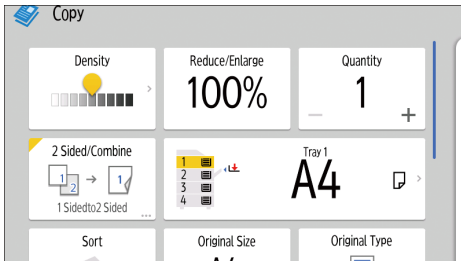

About how to use the application's screen, see page 74 "[Copy] (standard) Screen".

## Changing the Number of Sets

You can change the number of copy sets during copying.

### ★ Important

- This function can be used only when the Sort function is selected.

## When Using the Copy Application

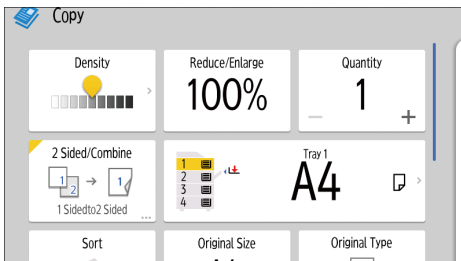

About how to use the application's screen, see page 74 "[Copy] (standard) Screen".

# Storing Data in the Document Server

The Document Server enables you to store documents being read with the copy feature on the hard disk of this machine. Thus you can print them later applying necessary conditions.

You can check the stored documents on the Document Server screen. For details about the Document Server, see page 167 "Storing Data".

2

## 1. Press [Store File].

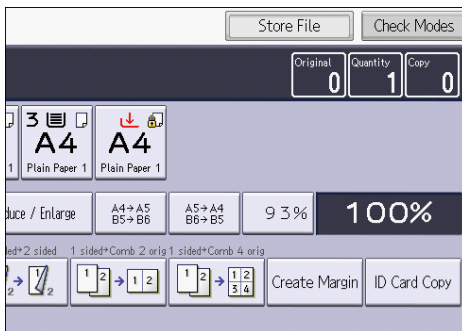

2. Enter a user name, file name, or password if necessary.
3. Specify a folder in which to store the document if necessary.
4. Press [OK].
5. Place the originals.
6. Make the scanning settings for the original.
7. Select the paper tray.
8. Press [Start].

When placing the original on the exposure glass, press [#] after all the originals have been scanned.

Stores scanned originals in memory and makes one set of copies. If you want to store another document, do so after copying is complete.



# 3. Fax

This chapter describes the transmission types and modes available for the fax function.

## Basic Procedure for Fax Transmissions (Memory Transmission)

This section describes the basic procedure for transmitting documents using Memory Transmission with the fax function.

You can specify the fax, IP-Fax, Internet Fax, e-mail, or folder destinations. Multiple types of destination can be specified simultaneously.

### ★ Important

- It is recommended that you call the receivers and confirm with them when sending important documents.
- If there is a power failure (the main power switch is turned off) or the machine is unplugged for about one hour, all the documents stored in memory are deleted. As soon as the main power switch is turned on, the Power Failure Report is printed to help you check the list of deleted files. See "When an Error for Fax Function Is Notified via a Report or E-Mail", Troubleshooting.

If memory is full (0% appears in "Memory" at the upper right of the screen), or if the combined total number of programmed destinations exceeds the maximum value, Memory Transmission is disabled. Use Immediate Transmission instead.

To send documents to Internet Fax or e-mail destinations or use the Email TX Results function, the sender's e-mail address must be registered in the Address Book. If the sender or the sender's e-mail address is not registered in the Address Book, register them in advance. For details about registering them, see "Registering User Information to the Address Book", For First-time Users.

### 📞 When Using the Fax Application

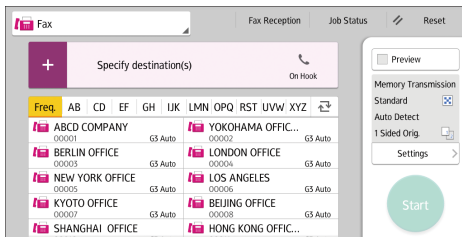

About how to use the application's screen, see page 76 "[Fax] (standard) Screen".

## Registering a Fax Destination

1. Press [Home]  at the bottom of the screen in the center.

2. Flick the screen to the left, and then press the [Address Book Management] icon.
3. Check that [Program / Change] is selected.
4. Press [New Program].
5. Press [Change] under "Name".  
The name entry display appears.
6. Enter the name, and then press [OK].
7. Press [▼Next].
8. Press the key for the classification you want to use under "Select Title".

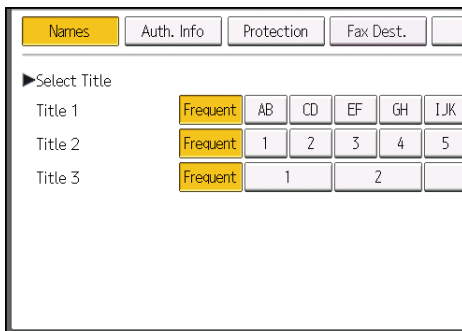

The keys you can select are as follows:



- [Frequent]: Added to the page that is displayed first.
- [AB], [CD], [EF], [GH], [IJK], [LMN], [OPQ], [RST], [UVW], [XYZ], [1] to [10]: Added to the list of items in the selected title.

You can select [Frequent] and one more key for each title.

9. Press [Fax Dest.].
10. Press [Change] under "Fax Destination".
11. Enter the fax number using the number keys, and then press [OK].



12. Specify optional settings such as "SUB Code", "SEP Code", and "International TX Mode".
13. Press [OK].

14. Press [User Tools] () on the top right of the screen.
15. Press [Home] () at the bottom of the screen in the center.

#### To change the fax number

1. Press [Change] under "Fax Destination".
2. Enter a new fax number using the number keys, and then press [OK].

#### To select line for fax number

1. Press [Select Line] under "Fax Destination".
2. Select the line to use.
3. Press [OK].

#### To program the SUB Code for fax number

1. Press [Adv. Features], and then press [SUB Code].
2. Press [Change] under "TX SUB Code".
3. Enter a new SUB Code, and then press [OK].
4. To change the password, press [Change] under "Password (SID)".
5. Enter a new password, and then press [OK].
6. Press [OK].

#### To program the SEP Code for fax number

1. Press [Adv. Features], and then press [SEP Code].
2. Press [Change] under "RX SEP Code".
3. Enter a new SEP Code, and then press [OK].
4. To change the password, press [Change] under "Password (PWD)".
5. Enter a new password, and then press [OK].
6. Press [OK].

#### To set the International TX Mode for fax number

1. Press [Change] under "International TX Mode".
2. Select [Off] or [On], and then press [OK].

#### To select the fax header for fax number

You can register the fax header in Program Fax Information in the system settings for Facsimile Features.

1. Press [Change] under "Fax Header".
2. Select between [1st Name] and [10th Name] or [Option Setting at TX], and then press [OK].

### To set label insertion for fax number

When Label Insertion is set to On, the receiver's name and standard messages are printed on the fax message when it is received.



1. Press [Change] under "Label Insertion".
2. Press [On].
3. Press [Change] under "Line 2".
4. Select a new standard message or press [Manual Entry] to enter a new message.
5. If you select [Manual Entry] in Step 4, enter the new message, and then press [OK].
6. Press [OK].
7. Press [Change] under "Line 3".
8. Select the new standard message, and then press [OK].
9. Press [OK].

## Changing or Deleting a Fax Destination

### ★ Important

- If you delete a destination that is a specified delivery destination, messages to its registered Personal Box, for example, cannot be delivered. Be sure to check the settings in the fax function before deleting any destinations.

### Changing a Fax Destination

1. Press [Home] () at the bottom of the screen in the center.
2. Flick the screen to the left, and then press the [Address Book Management] icon.
3. Check that [Program / Change] is selected.
4. Select the name whose fax destination you want to change.  
Press the name key, or enter the registered number using the number keys.  
You can search by the registered name, user code, fax number, folder name, e-mail address, or IP-Fax destination.
5. Press [Fax Dest.].
6. Change the settings.
7. Press [OK].
8. Press [User Tools] () on the top right of the screen.
9. Press [Home] () at the bottom of the screen in the center.

### Deleting a Fax Destination

1. Press [Home] () at the bottom of the screen in the center.



2. Flick the screen to the left, and then press the [Address Book Management] icon.
3. Check that [Program / Change] is selected.
4. Select the name whose fax destination you want to delete.

Press the name key, or enter the registered number using the number keys.

You can search by the registered name, user code, fax number, folder name, e-mail address, or IP-Fax destination.

5. Press [Fax Dest.].
6. Press [Change] under "Fax Destination".
7. Press [Delete All], and then press [OK] under "Fax Destination".

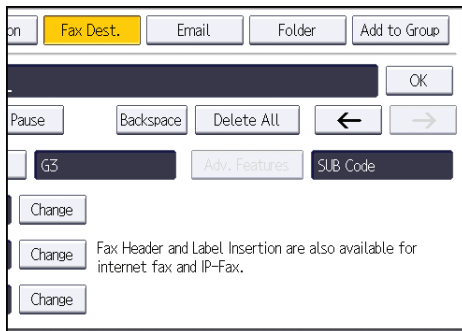

8. Press [OK].
9. Press [User Tools] (⚙️) on the top right of the screen.
10. Press [Home] (🏠) at the bottom of the screen in the center.

## Transmitting while Checking Connection to Destination (Immediate Transmission)

Using Immediate Transmission, you can send documents while checking the connection to the destination.

You can specify fax or IP-Fax destinations.

If you specify Internet Fax, e-mail, folder destinations, and group or multiple destinations, the transmission mode is automatically switched to Memory Transmission.

3

### ★ Important

- It is recommended that you call the receivers and confirm with them when sending important documents.

### 📞 When Using the Fax Application

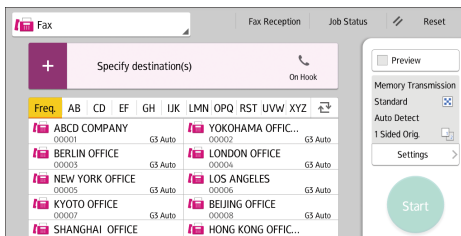

About how to use the application's screen, see page 76 "[Fax] (standard) Screen".

# Canceling a Fax Transmission

This section explains how to cancel a fax transmission.

## Canceling a Transmission Before the Original Is Scanned

Use this procedure to cancel a transmission before pressing [Start].

### When Using the Fax Application

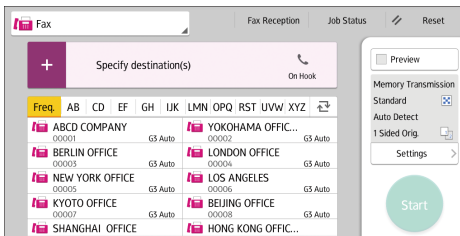

About how to use the application's screen, see page 76 "[Fax] (standard) Screen".

## Canceling a Transmission While the Original Is Being Scanned

Use this procedure to cancel scanning or transmitting of the original while it is being scanned.

If you cancel a transmission using the standard memory transmission function, you need to follow a different procedure to cancel the transmission. See page 117 "Canceling a Transmission After the Original Is Scanned".

### When Using the Fax Application

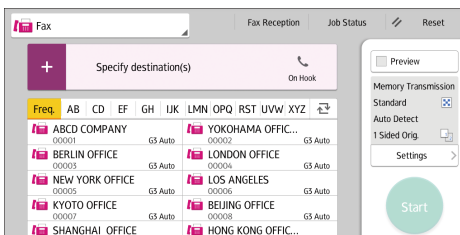

About how to use the application's screen, see page 76 "[Fax] (standard) Screen".

## Canceling a Transmission After the Original Is Scanned

Use this procedure to cancel a transmission after the original is scanned.

You can cancel transmission of a file while the file is being sent, stored in memory, or if it fails to transmit. All the scanned data is deleted from memory.

If the transmission finishes while this procedure is being processed, the transmission is not canceled. Note that the transmission duration is short if an Internet Fax, e-mail transmission, or folder transmission is being executed.

There are cases when a destination may not be selected as the destination appears as "✳", depending on the security settings.

To delete some destinations from a broadcast, see "Deleting a Destination from a Standby File", Fax.

### When Using the Fax Application

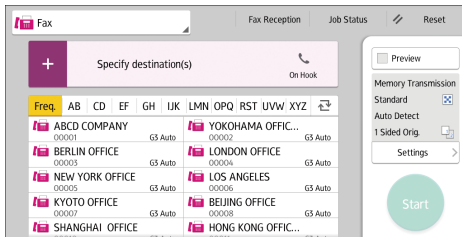

About how to use the application's screen, see page 76 "[Fax] (standard) Screen".

# Storing a Fax Document

You can store and send a document at the same time. You can also just store a document.

The following information can be set for the stored documents as necessary:

### User Name

You can set this function if necessary to know who and what departments stored documents in the machine. A user name can be selected from the Address Book or entered manually.

### File Name

You can specify a name for a stored document. If you do not specify a name, scanned documents will be automatically assigned names such as "FAX0001" or "FAX0002".

### Password

You can set this function so as not to send to unspecified people. A four to eight digit number can be specified as a password.

You can also change the file information after storing files.

**1. Place the original, and then specify the scan settings you require.**

Specify the [Original Orientation] setting correctly. If you do not, the top/bottom orientation of the original will not be displayed correctly in the preview.

For details about the setting, see "Setting the Original Orientation", Fax.

**2. Press [Store File].**

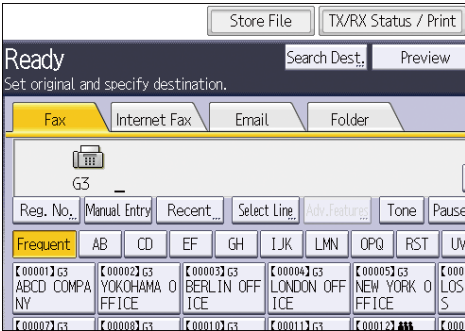

**3. Select [Send & Store] or [Store Only].**

Select [Send & Store] to send documents after they are stored.

Select [Store Only] to store documents.

#### 4. Set the user name, file name, and password as necessary.

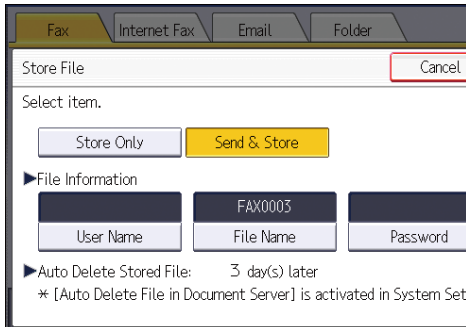

3

- **User Name**  
Press [User Name], and then select a user name. To specify an unregistered user name, press [Manual Entry], and then enter the name. After specifying a user name, press [OK].
- **Access Privileges**  
Depending on the security settings, [Access Privileges] might be displayed instead of [User Name]. For details about setting [Access Privileges], see "Specifying Access Privileges When Storing Files", Fax.
- **File Name**  
Press [File Name], enter a file name, and then press [OK].
- **Password**  
Press [Password], enter a password using the number keys, and then press [OK]. Re-enter the password for confirmation, and then press [OK].

#### 5. Press [OK].

#### 6. If you have selected [Send & Store], specify the receiver.

#### 7. Press [Start].

## Sending Stored Fax Documents

The machine sends documents stored with the fax function in the Document Server.

The documents stored in the Document Server can be sent again and again until they are deleted.

The stored documents are sent with the scan settings made when they were stored.

You can send stored documents after adding an original. For this operation, you can change the scan settings. The added original is not stored.

You cannot use the following transmission methods:

- Immediate transmission
- Parallel memory transmission

- On Hook dial
- Manual dial

### 1. Press [Select Stored File].

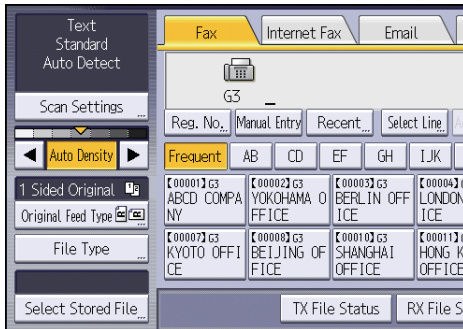

### 2. Select the documents to be sent.

When multiple documents are selected, they are sent in the order of selection.

- Press [User Name] to place the documents in order by programmed user name.
- Press [File Name] to place the documents in alphabetical order.
- Press [Date] to place the documents in order of programmed date.
- Press [Queue] to arrange the order of the documents to be sent.

To view details about stored documents, press [Details].

Press the Thumbnails key to switch the screen to thumbnail display.

### 3. If you select a document with a password, enter the password using the number keys, and then press [OK].

### 4. When you want to add your originals to stored documents and send them all at once, press [Original + Stored File] or [Stored file + Original].

When [Original + Stored File] is pressed, the machine sends the originals, and then stored files.

When [Stored file + Original] is pressed, the machine sends the stored files, and then originals.

### 5. Press [OK].

### 6. To add an original to stored documents, place the original, and then select any scan settings you require.

### 7. Specify the destination, and then press [Start].

# Printing the Records Manually

To print the records manually, select a printing method: [All], [Print per File No.], [Print per User], or [Specified Print Period].

## All

Prints the results of communications in order made.

## Print per File No.

Prints only the results of communications specified by file number.

## Print per User

Prints the results of communications by individual senders.

## Specified Print Period

Prints the communication results in the specified time period.

### When Using the Fax Application

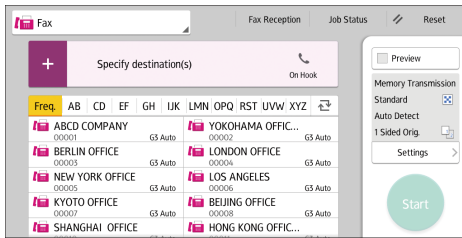

About how to use the application's screen, see page 76 "[Fax] (standard) Screen".



# 4. Print

This chapter describes frequently used printer functions and operations. For information not included in this chapter, see Print available on our website.

## Installing the Printer Driver for Network Connection (Windows)

When the machine and the computer are connected to the same network, the installer searches for the machine to install the printer driver. If the installer cannot find the machine, specify the IP address or machine name to install the printer driver.

### Installing the PCL 6 Printer Driver from the CD-ROM

- 1. Set the CD-ROM in the computer.

If the installer does not start automatically, double-click [Setup.exe] in the root directory of the CD-ROM.

- 2. Select a language, and then click [OK].
- 3. Click [Install from Disk].

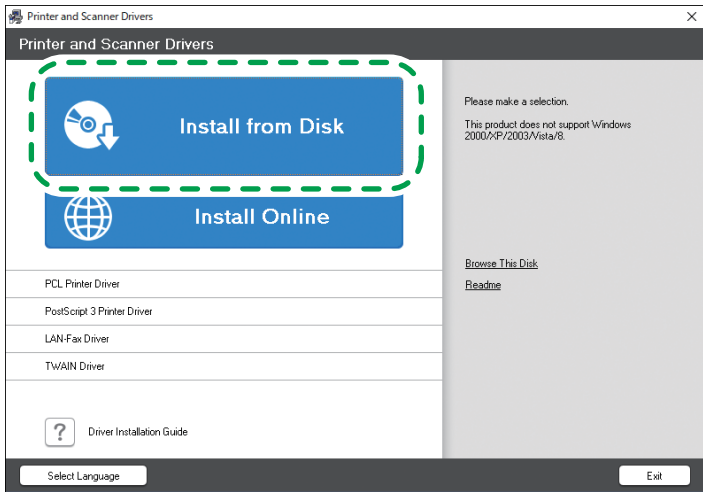

DZC992

- 4. Click [Network Printer(s)].

5. On the "License Agreement" screen, select [I accept the agreement.], and then click [Next].

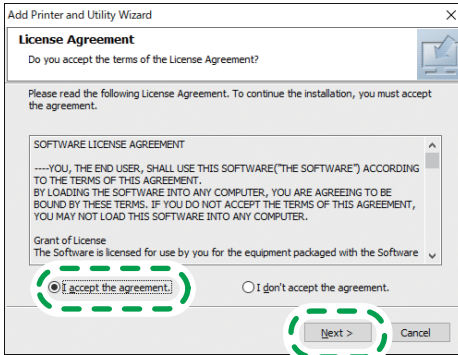

DZC081

6. Confirm the "Confirm Network Connection" screen, and then click [Next].

The search detects devices connected to the network.

7. Select this machine from among the devices, and then click [Install].

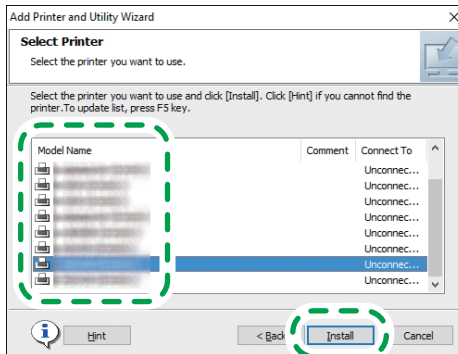

DZC080

8. If the "Set Port" screen is displayed, select the setting method of the port.

This screen is displayed when the computer cannot access the machine.

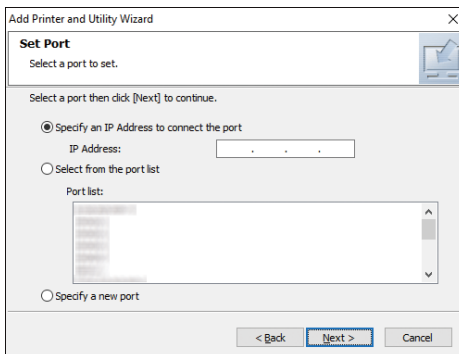

Specify the port to use for the connection between the computer and machine using one of the following methods:

#### To specify the IP address

1. Enter the IP address of the machine, and then click [Next].
2. Proceed to Step 9.

#### To select from the port list

1. Select the port to use for the connection between the computer and machine, and then click [Next].
2. Proceed to Step 9.

#### To create a new port

1. Select [Specify a new port], and then click [Next].
2. On the "Add Printer and Utility Wizard" screen, select [Standard TCP/IP Port] and click [Next].
3. On the "Add Standard TCP/IP Printer Port Wizard" screen, click [Next].
4. On the "Add port" screen, enter the printer name or IP address of the machine, and then click [Next].

The port name is automatically entered. You can change the port name.

5. When the "Additional port information required" screen is displayed, select [RICOH Network Printer C model], and then click [Next].
6. Click [Finish].

### 9. Specify the name of the printer to install, and whether to use it as the default printer.

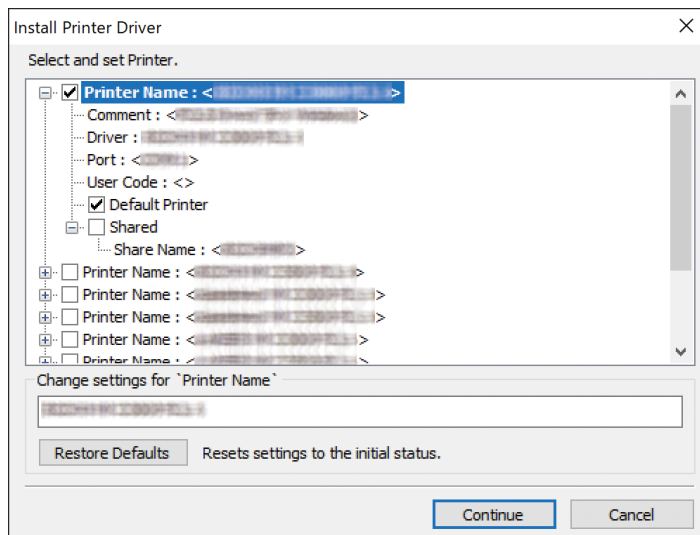

**10. Click [Continue].**

Printer driver installation starts.

**11. Click [Finish].**

When you are prompted to restart your computer, restart it by following the instructions that appear.

# Installing the Printer Driver for USB Connection (Windows)

When you connect the machine and the computer with a USB cable, the installer searches for the machine to install the printer driver.

## ★ Important

- Follow the instructions of the installer to connect the USB cable.

## Installing the Printer Driver from the CD-ROM

### 1. Set the CD-ROM in the computer.

If the installer does not start automatically, double-click [Setup.exe] in the root directory of the CD-ROM.

2. Select a language, and then click [OK].
3. Click [Install from Disk].

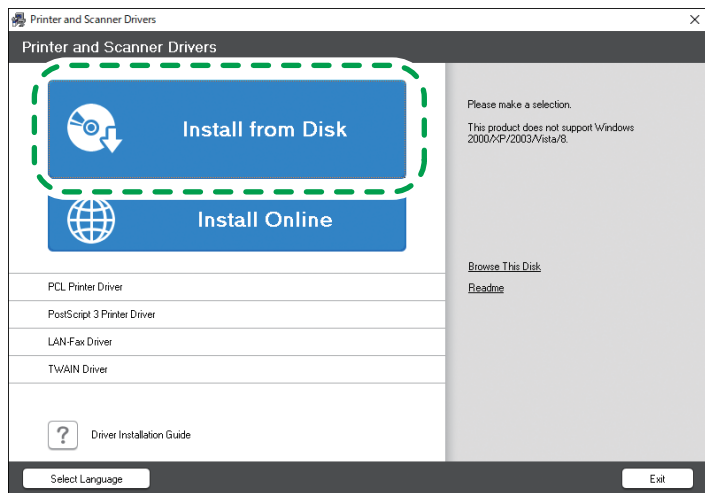

### 4. Click [USB printer(s)].

5. On the "License Agreement" screen, select [I accept the agreement], and then click [Next].

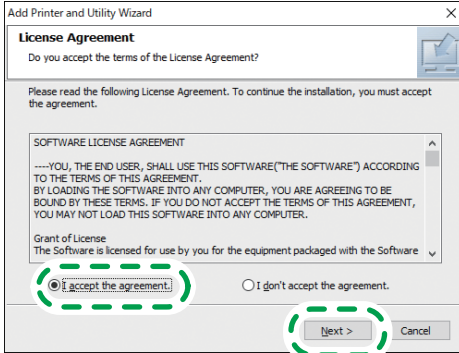

DZC081

6. Select [Add a new printer], and then click [Next].
7. Select this machine from among the devices, and then click [Next].

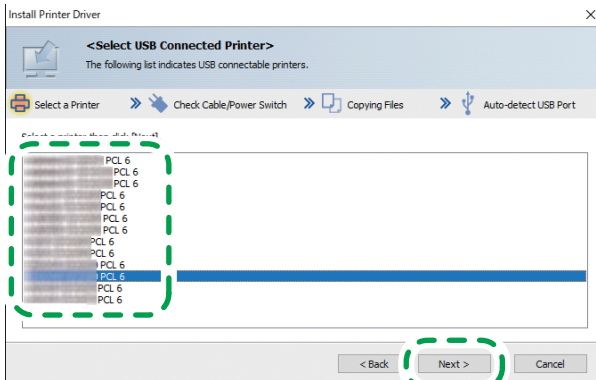

DZC092

8. Disconnect the USB cable from the machine and turn off the power of the machine, and then click [Next].

Printer driver installation starts.

9. Following the instructions on the "Auto-detect USB Port" screen, connect the machine and the computer with the USB cable, and then turn on the power of the machine.

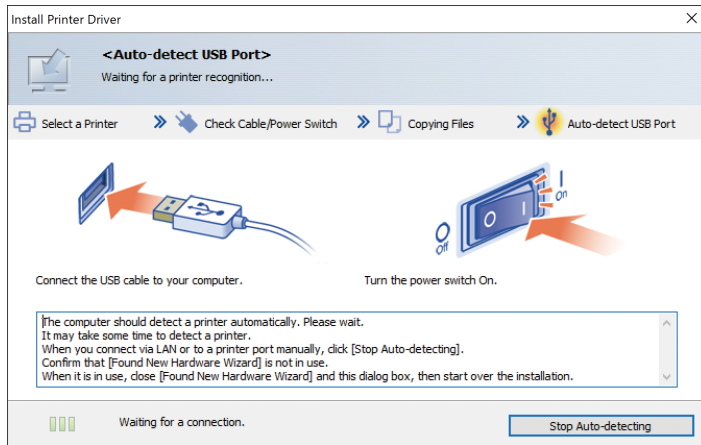

- The search detects the machine connected by the USB cable.
- If the machine is not detected, click [Stop Auto-detecting]. Even if the connection is canceled, the installation is complete. After the installer screen is closed, the machine is added automatically when it is connected to the computer with the USB cable.

10. Click [Finish].

## Displaying the Printer Driver Properties

This section explains how to open the printer driver properties from [Control Panel].

### ★ Important

- **Manage Printers permission is required to change the printer settings. Log on as an Administrators group member.**
- **You cannot change the machine default settings for individual users. Settings made in the printer properties dialog box are applied to all users.**

1. Right-click the [Start] menu, click [Control Panel].
2. Click [View devices and printers].
3. Right-click the icon of the printer you want to use.
4. Click [Printer properties].



# Standard Printing

## ★ Important

- Duplex printing is selected as the default setting. If you want to print on only one side, select [Off] for the two-sided printing setting.
- If you send a print job via USB 2.0 while the machine is in Sleep mode, an error message might appear when the print job is complete. In this case, check if the document was printed.

## When Using the PCL 6 Printer Driver

1. Click the menu button of the application you are using, and then click [Print].
2. Select the printer you want to use.
3. Click [Preferences].

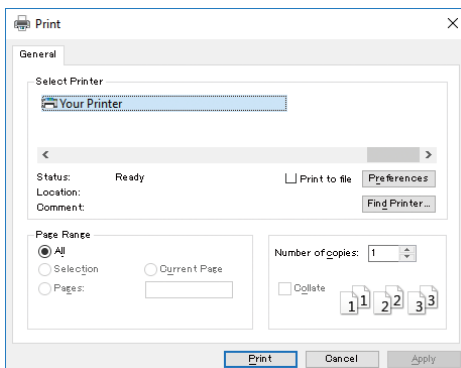

4. Select the [Frequently Used Settings] tab.

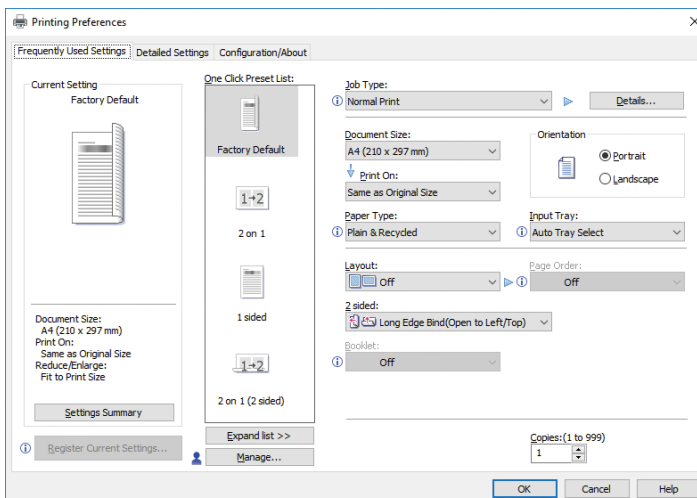

5. In the "Job Type:" list, select [Normal Print].

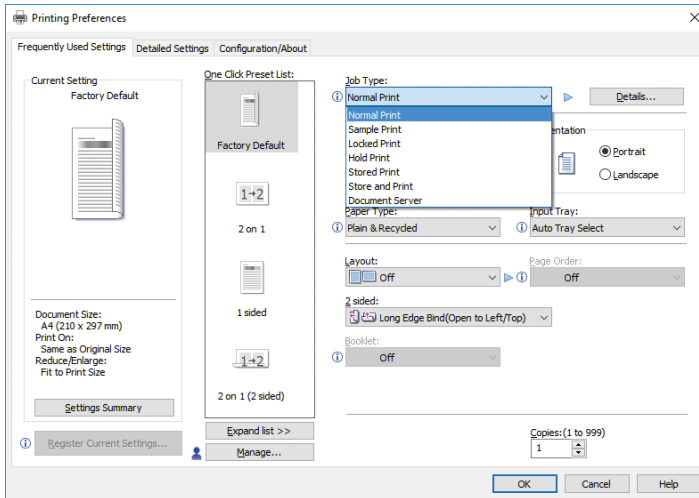

6. In the "Document Size:" list, select the size of the original to be printed.

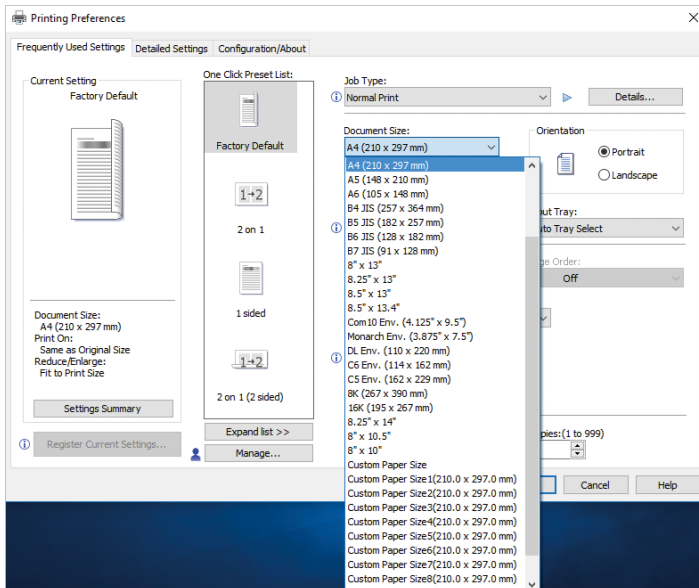

7. In the "Orientation" area, select [Portrait] or [Landscape] as the orientation of the original.

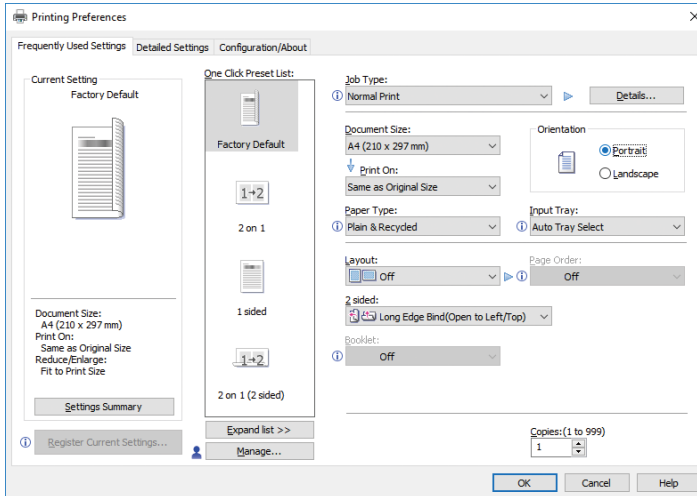

8. In the "Paper Type:" list, select the type of paper that is loaded in the paper tray.

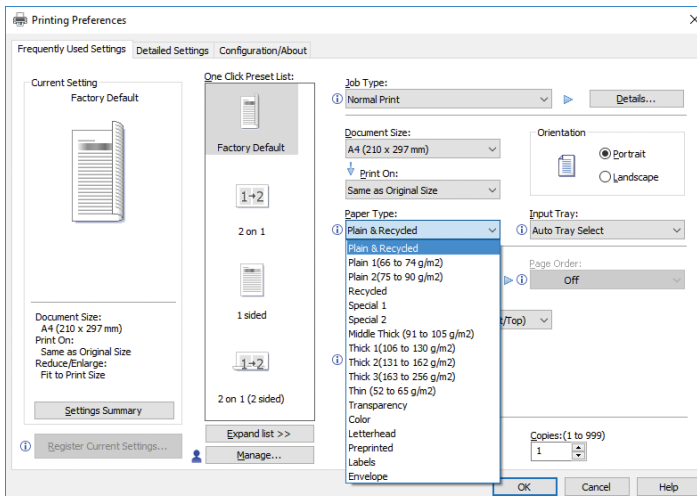

9. In the "Input Tray:" list, select the paper tray that contains the paper you want to print onto.

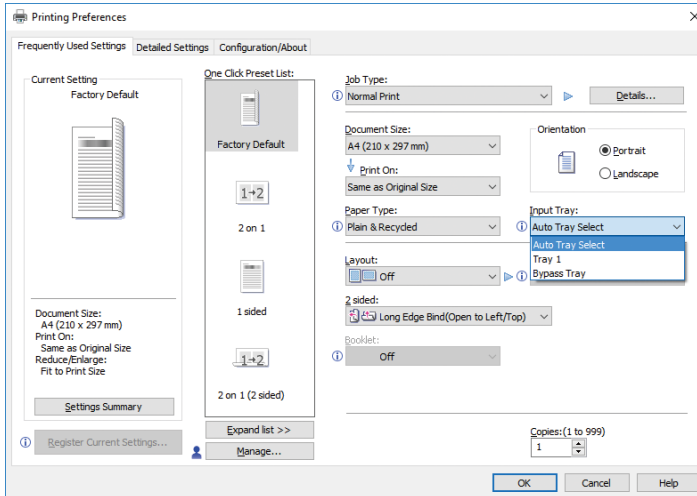

If you select [Auto Tray Select] in the "Input Tray:" list, the paper tray is automatically selected according to the paper size and type specified.

10. If you want to print multiple copies, specify a number of sets in the "Copies:" box.

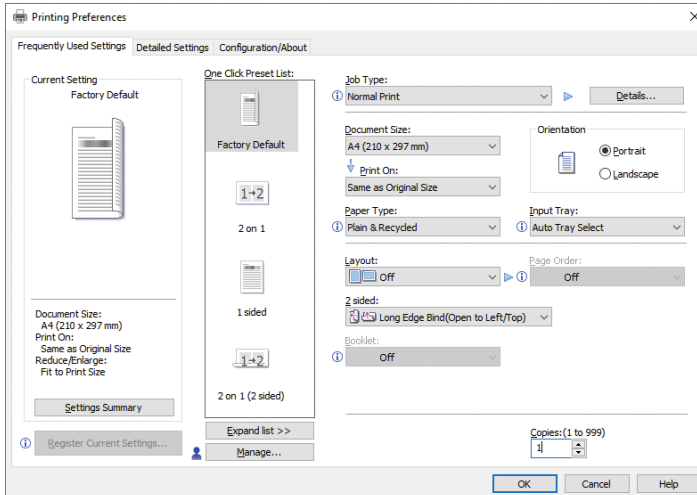

11. Click [OK].
12. Start printing from the application's [Print] dialog box.

# Printing on Both Sides of Sheets

This section explains how to print on both sides of each page using the printer driver.

**★ Important**

- The paper types that can be printed on both sides are as follows:
  - Plain & Recycled, Plain 1 (66 to 74 g/m<sup>2</sup>), Plain 2 (75 to 90 g/m<sup>2</sup>), Recycled, Special 1, Middle Thick (91 to 105 g/m<sup>2</sup>), Thick 1 (106 to 130 g/m<sup>2</sup>), Thick 2 (131 to 162 g/m<sup>2</sup>), Thin (52 to 65 g/m<sup>2</sup>), Letterhead





## How to Print on Both Sides of the Paper (When Using the PCL 6 Printer Driver)

1. Click the menu button of the application you are using, and then click [Print].
2. Select the printer you want to use.
3. Click [Preferences].
4. Click the [Frequently Used Settings] tab.

You can also click the [Detailed Settings] tab, and then click [2 Sided/Layout/Booklet] in the "Menu:" box.

5. Select the method for binding the output pages in the "2 sided:" list.

You can select which way the bound pages open by specifying which edge to bind.

Orientation	Long Edge Bind	Short Edge Bind
Portrait		
Landscape		

6. Change any other print settings if necessary.
7. Click [OK].
8. Start printing from the application's [Print] dialog box.

# Combining Multiple Pages into Single Page

This section explains how to print multiple pages onto a single sheet. The combine printing function allows you to economize on paper by printing multiple sheets at reduced size onto a single sheet.

## How to Print Multiple Pages onto a Single Sheet (When Using the PCL 6 Printer Driver)

1. Click the menu button of the application you are using, and then click [Print].
2. Select the printer you want to use.
3. Click [Preferences].
4. Click the [Frequently Used Settings] tab.

You can also click the [Detailed Settings] tab, and then click [2 Sided/Layout/Booklet] in the "Menu:" box.

5. Select the combination pattern in the "Layout:" list, and then specify the method for combining pages in the "Page Order:" list.

This function allows you to print 2, 4, 6, 9, or 16 pages at reduced size onto a single sheet and to specify a page ordering pattern for the combination. When combining 4 or more pages onto a single sheet of paper, four patterns are available.

The following illustrations show example page ordering patterns for 2- and 4-page combinations.

### 2 Pages per Sheet

Orientation	From Left to Right/Top to Bottom	From Right to Left/Top to Bottom
Portrait		
Landscape		

#### 4 Pages per Sheet

Right, then Down	Down, then Right	Left, then Down	Down, then Left																
<table border="1"><tr><td>1</td><td>2</td></tr><tr><td>3</td><td>4</td></tr></table>	1	2	3	4	<table border="1"><tr><td>1</td><td>3</td></tr><tr><td>2</td><td>4</td></tr></table>	1	3	2	4	<table border="1"><tr><td>2</td><td>1</td></tr><tr><td>4</td><td>3</td></tr></table>	2	1	4	3	<table border="1"><tr><td>3</td><td>1</td></tr><tr><td>4</td><td>2</td></tr></table>	3	1	4	2
1	2																		
3	4																		
1	3																		
2	4																		
2	1																		
4	3																		
3	1																		
4	2																		

To draw a border line around each page, select the [Draw Frame Border] check box in [2 Sided/ Layout/Booklet] in the [Detailed Settings] tab.

6. Change any other print settings if necessary.
7. Click [OK].
8. Start printing from the application's [Print] dialog box.

# Printing on Envelopes

Configure the paper settings appropriately using both the printer driver and the control panel.

---

## Configuring Envelope Settings Using the Control Panel

---

For details about how to configure the settings for each tray, see "Changing Paper Size Settings" or "Specifying the Paper Setting for the Bypass Tray", For First-time Users.

When changing the settings, select the appropriate paper weight for the envelopes loaded in the tray. For details about how to configure the settings, see "Specifying Paper Type and Thickness Settings", For First-time Users.

After configuring the envelope settings on the control panel, configure the printer driver settings.

For details, see page 138 "Printing on Envelopes Using the Printer Driver".

---

## Printing on Envelopes Using the Printer Driver

---

Before configuring envelope settings in the printer driver, configure the control panel settings.

For details see page 138 "Configuring Envelope Settings Using the Control Panel".

1. Click the menu button of the application you are using, and then click [Print].
2. Select the printer you want to use.
3. Click [Preferences].
4. In the "Document Size:" list, select the envelope size.

When using the PCL 5e printer driver, click the [Paper] tab, and then select the bypass tray in the "Input Tray:" list.

5. In the "Input Tray:" list, select the paper tray where the envelopes are loaded.
6. In the "Paper Type:" list, select [Envelope].
7. Change any other print settings if necessary.
8. Click [OK].
9. Start printing from the application's [Print] dialog box.



# Saving and Printing Using the Document Server

The Document Server enables you to store documents on the machine's hard disk, and allows you to edit and print them as necessary.

## ★ Important

- Do not cancel the file transfer process while the data is being sent to the Document Server. The process may not be canceled properly. If you accidentally cancel a print job, use the control panel of the machine to delete the transferred data. For details about how to delete documents that are stored in the Document Server, see "Deleting Stored Documents", Copy/Document Server, or Web Image Monitor Help.
- Up to 3,000 files can be stored in the Document Server. New files cannot be stored when 3,000 files have already been stored. Even if less than 3,000 files are stored, new files cannot be stored when
  - The number of pages in a document exceeds 2,000.
  - The total number of stored pages in the machine and the sent data has reached 9,000 (It may be fewer depending on the print data).
  - The hard disk is full.
- Data stored in the Document Server is deleted after three days (72 hours) by the factory default. We recommend you back up the data.

You can send data created on a client computer to the Document Server. The procedure to specify settings such as the user ID may differ depending on the operating system or the printer driver you are using. The following printer drivers can be used:

### Windows

PCL 5e/6, PostScript 3 printer driver

### OS X and macOS

PostScript 3<sup>\*</sup> printer driver

---

## Storing Documents in Document Server

---

## ★ Important

- If the machine is not used as the Document Server, the maximum number of the documents that can be stored in the server may be less than the number described in the specification.
1. Click the menu button of the application you are using, and then click [Print].
  2. Select the printer you want to use.

3. Click [Preferences].
4. In the "Job Type:" list, click [Document Server].
5. Click [Details...].
6. Enter a user ID, file name, password, and user name as required.
7. Specify the folder number to store the document in the "Folder Number" box.  
When "0" is specified in the "Folder Number:" box, documents will be saved in the Shared folder.
8. If the folder is protected by a password, enter the password in the "Folder Password:" box.
9. Click [OK].
10. Change any other print settings if necessary.
11. Click [OK].
12. Start printing from the application's [Print] dialog box.

---

## Managing Documents Stored in Document Server

---

You can view or delete the documents stored in the machine's Document Server using a web browser from a client computer connected to the network. (We use Web Image Monitor installed on this machine.)

# Using the Quick Print Release Function

The quick applications that are installed on this machine allow you to operate some of the printer functions from a single screen. Using the Quick Print Release function, you can view the list of documents that are stored on the machine. From the list, any documents can be selected and printed. The print settings of the document and the date and time to send the document can be changed as well.

1. Press [Home]  at the bottom of the screen in the center.
2. Press the [Quick Print Release] icon.
3. Select the user as required.
4. If necessary, enter the password for the documents.

The list of both the documents that have not password specified, and that matches the entered password is displayed.

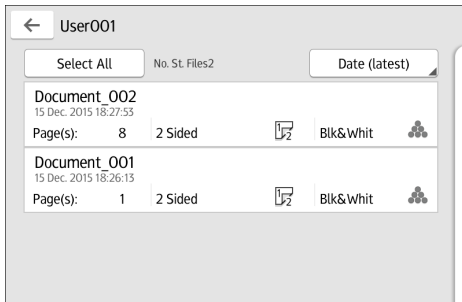

## 5. Select documents.

More than one document can be selected at one time.

You can perform the following operations on the selected documents:

- Delete  
Deletes the selected documents.
- Preview  
Shows the preview image of the first page of the document.  
No previews can be displayed when more than one document is selected.
- Print Settings  
Configures the print settings of the document.
- Manage Files  
Specifies the date and time to send the document, and the password.  
The file information cannot be modified when more than one document is selected.

## 6. Press [Print].

 **Note**

- If you change settings for [Administrator Authentication Management] or [Enhance File Protection] using an external application such as Web Image Monitor while using the Quick Print Release function, this function is terminated automatically.

# Using the Print/Scan(Memory Storage Device) Function

## ⚠ CAUTION

- Keep SD cards and USB flash memory devices out of reach of children. If a child accidentally swallows an SD card or USB flash memory device, consult a doctor immediately.

The Print/Scan(Memory Storage Device) function allows you to read and print files that are stored on a memory storage device such as an SD card or USB flash memory device. Also, you can save the scanned data on a memory storage device.

The files in the following formats can be printed using the Print/Scan(Memory Storage Device) function: JPEG, TIFF, PDF, and XPS. The scanned data can be saved in JPEG, TIFF, or PDF format.

4

### Printing a file in a memory storage device

1. Press [Home] (🏠) at the bottom of the screen in the center.
2. Press the [Print/Scan(Memory Storage Device)] icon.
3. Press [Print from Storage Device].
4. Insert a memory storage device in the media slot.

For details about how to insert a memory storage device, see "Inserting/Removing an SD Card" or "Inserting/Removing USB Flash Memory Device", For First-time Users.

5. Press [USB] or [SD Card], depending on the type of the storage device.
6. Select the document to print.

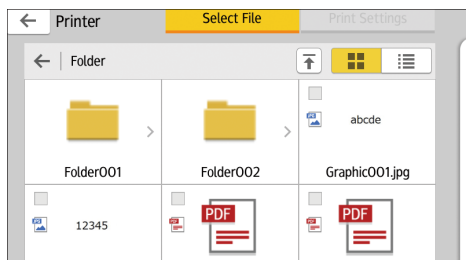

You can perform the following operations on the selected document:

- Preview  
Shows the preview image of the first page of the document.
- Selected  
Displays the list of the selected documents.

7. If necessary, press [Print Settings] to change the settings such as the number of copies or duplex printing.

8. Press [Start].

**Saving the scanned data in a memory storage device**

1. Press [Home] (🏠) at the bottom of the screen in the center.

2. Press the [Print/Scan(Memory Storage Device)] icon.

3. Press [Scan to Storage Device].

4. Insert a memory storage device in the media slot.

For details about how to insert a memory storage device, see "Inserting/Removing an SD Card" or "Inserting/Removing USB Flash Memory Device", For First-time Users.

5. Press [USB] or [SD Card], depending on the type of the storage device that you are using.

6. Specify the location to save the scanned data.

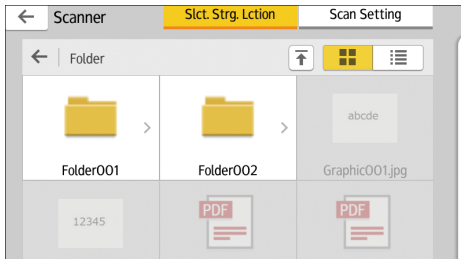

7. Place the original.

8. If necessary, press [Scan Setting] to change the settings such as the file type or scan resolution.

9. To see the scanned image before saving it to a file, press [Preview].

10. Press [Start].

11. Press [Finish Scan] after scanning of the original has been completed.

If there are more originals to be scanned, place the next original, and then press [Scan Next Original].

12. When the preview screen appears, check the scanned image, and then press [Save].

**Note**

- If the file name is not specified in [Scan Setting], the scanned image is saved under the name that conforms to the following naming rules:
  - For single page format:  
Transmission date and time (YYYYMMDDHHMMSSMMM) + 4 digit serial page number (\_nnnn) + extension (.tif/.jpg/.pdf)

For example, when you send 10-page original in jpeg format at 15:30:15.5 on Dec. 31, 2020, the file names are from "20201231153015500\_0001.jpg" to "20201231153015500\_0010.jpg".

- For multi page format:  
Transmission date and time (YYYYMMDDHHMMSSMMM) + extension (.tif/.jpg/.pdf)  
For example, when you send 10-page original in PDF format at 15:30:15.5 on Dec. 31, 2020, the file name is "20201231153015500.pdf".
- When you save scanned data to a memory storage device, use characters which correspond to the ASCII codes for the file name. If you use characters which is not correspond to the ASCII codes, the machine may not read or save the documents.
- Certain types of USB flash memory device and SD cards cannot be used.





# 5. Scan

This chapter describes frequently used scanner functions and operations. For information not included in this chapter, see Scan available on our website.

## Basic Procedure When Using Scan to Folder

This section explains how to send scanned documents to a specified folder.

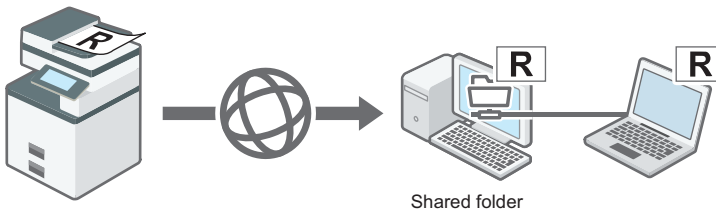

DVL855

### ★ Important

- Before performing this procedure, see "Preparation for Sending by Scan to Folder", Scan and confirm the details of the destination computer. See also "Registering Folders", For First-time Users, and register the address of the destination computer to the address book.

### 📄 When Using the Scanner Application

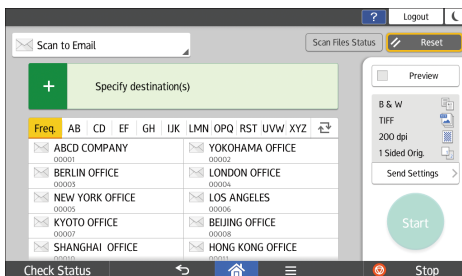

About how to use the application's screen, see page 82 "[Scanner] (standard) Screen".

## Creating a Shared Folder on a Computer Running Windows/Confirming a Computer's Information

The following procedures explain how to create a shared folder on a computer running Windows, and how to confirm the computer's information. In these examples, Windows 10 is the operating system, and the computer is a member in a network domain. Write down the confirmed information.

## Step 1: Confirming the user name and computer name

Confirm the user name and the name of the computer you will send scanned documents to.

1. On the [Start] menu, click [Windows System], and then click [Command Prompt].
2. Enter the command "ipconfig/all", and then press the [Enter] key.
3. Confirm the name of the computer.

The computer's name is displayed under [Host Name].

You can also confirm the IPv4 address. The address displayed under [IPv4 Address] is the IPv4 address of the computer.

```
C:\Users\User.A050885512>ipconfig/all
Windows IP Configuration

Host Name . . . . . : A050885512
Node Type . . . . . : Hybrid
IP Routing Enabled. . . . . : No
WINS Proxy Enabled. . . . . : No
DNS Suffix Search List. . . . . : rfg.rfgad.ricoh.co.jp
rfgad.ricoh.com
nts.ricoh.co.jp

Wireless LAN adapter Wireless Network Connection:

Connection-specific DNS Suffix . : 
Description . . . . . : Intel(R) Dual Band Wireless-AC 8095
Physical Address. . . . . : 18-5E-0F-DD-E4-00
DHCP Enabled. . . . . : Yes
Autoconfiguration IPv4 Address. . : 169.254.239.36
Default Gateway . . . . . : 
NetBIOS over Tcpip. . . . . : Enabled
```

DVL853

4. Enter the command "set user", and then press the [Enter] key.

Be sure to put a space between "set" and "user".

5. Confirm the user name.

The user name is displayed under [USERNAME].

```
C:\Users\User.A050885512>set user
USERDOMAIN=A050885512
USERNAME=User
USERPROFILE=C:\Users\User.A050885512
```

DVL852

## Step 2: Creating a shared folder on a computer running Microsoft Windows

Create a shared destination folder in Windows and enable sharing. In the following procedure, a computer which is running under Windows 10 and participating in a domain is used as an example.

### ★ Important

- You must log in as an Administrators group member to create a shared folder.

- If "Everyone" is left selected in Step 6, the created shared folder will be accessible by all users. This is a security risk, so we recommend that you give access rights only to specific users. Use the following procedure to remove "Everyone" and specify user access rights.
1. Create a folder, just as you would create a normal folder, in a location of your choice on the computer.
  2. Right-click the folder, and then click [Properties].
  3. On the [Sharing] tab, click [Advanced Sharing...].
  4. Select the [Share this folder] check box.
  5. Click [Permissions].
  6. In the [Group or user names:] list, select "Everyone", and then click [Remove].
  7. Click [Add...].
  8. In the [Select Users, Computers, Service Accounts, or Groups] window, click [Advanced...].
  9. Specify one or more object types, select a location, and then click [Find Now].
  10. From the list of results, select the groups and users you want to grant access to, and then click [OK].
  11. In the [Select Users, Computers, Service Accounts, or Groups] window, click [OK].
  12. In the [Group or user names:] list, select a group or user, and then, in the [Allow] column of the permissions list, select either the [Full Control] or [Change] check box.  
Configure the access permissions for each group and user.
  13. Click [OK].

### Step 3: Specifying access privileges for the created shared folder

---

If you want to specify access privileges for the created folder to allow other users or groups to access the folder, configure the folder as follows:

1. Right-click the folder created in Step 2, and then click [Properties].
2. On the [Security] tab, click [Edit...].
3. Click [Add...].
4. In the [Select Users, Computers, Service Accounts, or Groups] window, click [Advanced...].
5. Specify one or more object types, select a location, and then click [Find Now].
6. From the list of results, select the groups and users you want to grant access to, and then click [OK].
7. In the [Select Users, Computers, Service Accounts, or Groups] window, click [OK].

8. In the [Groups or user names:] list, select a group or user, and then, in the [Allow] column of the permissions list, select either the [Full Control] or [Modify] check box.
9. Click [OK].

## Registering an SMB Folder

If User Authentication is specified, contact your administrator.

1. Press [Home] (🏠) at the bottom of the screen in the center.
2. Flick the screen to the left, and then press the [Address Book Management] icon.
3. Check that [Program / Change] is selected.
4. Press [New Program].
5. Press [Change] under "Name".  
The name entry display appears.
6. Enter the name, and then press [OK].
7. Press [▼Next].
8. Press the key for the classification you want to use under "Select Title".

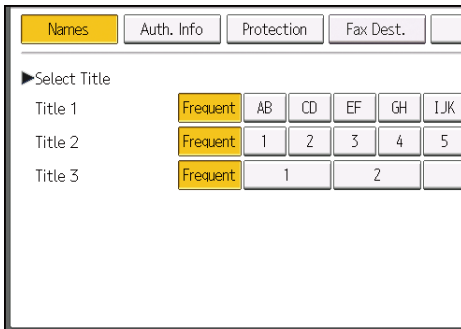

The keys you can select are as follows:

- [Frequent]: Added to the page that is displayed first.
- [AB], [CD], [EF], [GH], [IJK], [LMN], [OPQ], [RST], [UVW], [XYZ], [1] to [10]: Added to the list of items in the selected title.

You can select [Frequent] and one more key for each title.

**9. Press [Auth. Info], and then press [▼Next].**

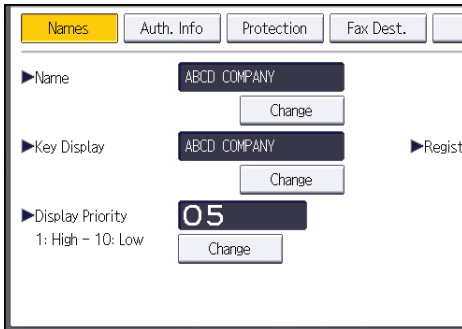

**10. Press [Specify Other Auth. Info] on the right side of "Folder Authentication".**

When [Do not Specify] is selected, the SMB User Name and SMB Password that you have specified in "Default User Name / Password (Send)" of File Transfer settings are applied.

**11. Press [Change] under "Login User Name".**

**12. Enter the login user name of the destination computer, and then press [OK].**

You can enter up to 64 characters (128 bytes) for the user name.

**13. Press [Change] under "Login Password".**

**14. Enter the password of the destination computer, and then press [OK].**

You can enter up to 64 characters (128 bytes) for the password.

**15. Enter the password again to confirm, and then press [OK].**

**16. Press [Folder].**

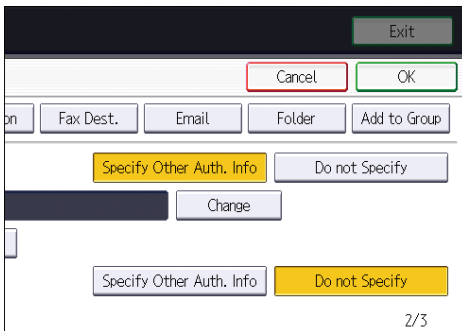

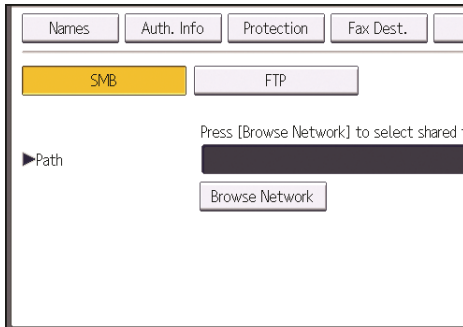
**17. Check that [SMB] is selected.****18. Press [Change] or [Browse Network], and then specify the folder.**

To specify a folder, you can either enter the path manually or locate the folder by browsing the network. You can enter a path up to 256 characters (256 bytes).

5

For details about how to specify the path manually, see page 152 "Locating the SMB folder manually".

For details about how to specify the path using Browse Network, see page 153 "Locating the SMB folder using Browse Network".

**19. Press [Connection Test] to check the path is set correctly.****20. Press [Exit].**

If the connection test fails, check the settings, and then try again.

**21. Press [OK].****22. Press [User Tools] (⚙️) on the top right of the screen.****23. Press [Home] (🏠) at the bottom of the screen in the center.****Locating the SMB folder manually****1. Press [Change] under "Path".****2. Enter the path where the folder is located.**

You can enter a path up to 256 characters (256 bytes).

Enter the path using this format: "\\ServerName\Share- Name\PathName".

For example: if the name of the destination computer is "User", and the folder name is "Share", the path will be \\User\Share.

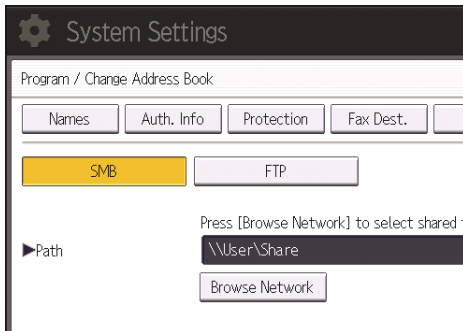

You can also enter an IPv4 address.

If the network does not allow automatic obtaining of IP addresses, include the destination computer's IP address in the path. For example: if the IP address of the destination computer is "192.168.0.191", and the folder name is "Share", the path will be \\192.168.0.191\Share.

### 3. Press [OK].

If the format of the entered path is not correct, a message appears. Press [Exit], and then enter the path again.

5

## Locating the SMB folder using Browse Network

### 1. Press [Browse Network].

The client computers sharing the same network as the machine appear.

Network display only lists client computers you are authorized to access.

### 2. Select the group that contains the destination computer.

### 3. Select the computer name of the destination computer.

Shared folders under it appear.

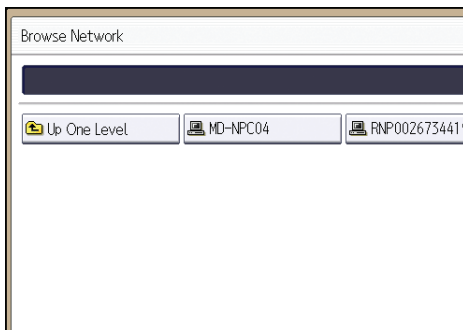

You can press [Up One Level] to switch between levels.



If you have not specified folder authentication, or if an incorrect user name or password has been entered for folder authentication, the login screen appears.

1. Press [Login].
2. Enter the login user name, and then press [OK].  
Enter the login user name specified for folder authentication.
3. Enter the password, and then press [OK].  
The path to the selected folder appears.  
If a message appears, press [Exit], and then enter the login user name and password again.
4. **Select the folder you want to register.**
5. Press [OK].

## Deleting an SMB registered folder

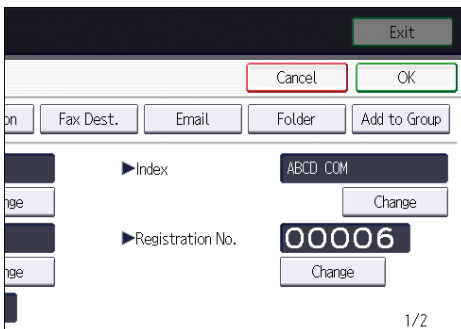
1. Press [Home]  at the bottom of the screen in the center.
2. Flick the screen to the left, and then press the [Address Book Management] icon.
3. Check that [Program / Change] is selected.
4. **Select the name whose folder you want to delete.**  
Press the name key, or enter the registered number using the number keys.  
You can search by the registered name, user code, fax number, folder name, e-mail address, or IP-Fax destination.
5. Press [Folder].



6. **Press the protocol which is not currently selected.**  
A confirmation message appears.
7. Press [Yes].
8. Press [OK].
9. Press [User Tools]  on the top right of the screen.
10. Press [Home]  at the bottom of the screen in the center.



## Entering the Path to the Destination Manually

### When Using the Scanner Application

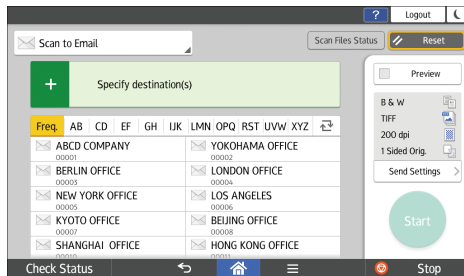

About how to use the application's screen, see page 82 "[Scanner] (standard) Screen".

# Basic Procedure for Sending Scan Files by E-mail

This section explains how to send scanned documents as an e-mail attachment.

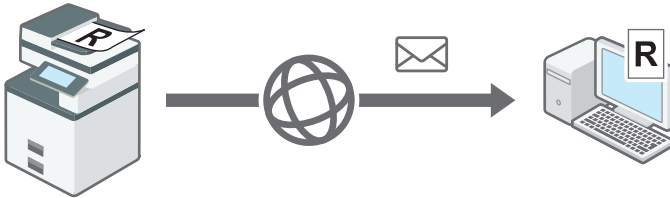

DVL856

5

## When Using the Scanner Application

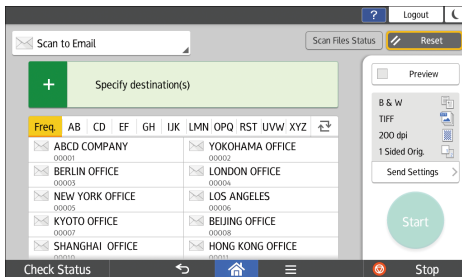

About how to use the application's screen, see page 82 "[Scanner] (standard) Screen".

## Registering an E-mail Destination

1. Press [Home]  at the bottom of the screen in the center.
2. Flick the screen to the left, and then press the [Address Book Management] icon.
3. Check that [Program / Change] is selected.
4. Press [New Program].
5. Press [Change] under "Name".  
The name entry display appears.
6. Enter the name, and then press [OK].
7. Press [▼Next].

## 8. Press the key for the classification you want to use under "Select Title".

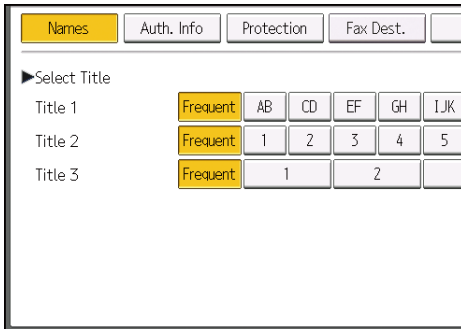

The keys you can select are as follows:

- [Frequent]: Added to the page that is displayed first.
- [AB], [CD], [EF], [GH], [IJK], [LMN], [OPQ], [RST], [UVW], [XYZ], [1] to [10]: Added to the list of items in the selected title.

You can select [Frequent] and one more key for each title.

## 9. Press [Email].

## 10. Press [Change] under "Email Address".

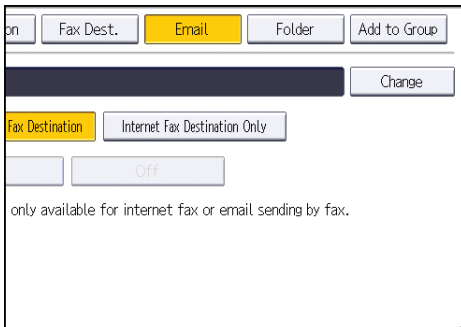

## 11. Enter the e-mail address, and then press [OK].

You can enter up to 128 characters for the e-mail address.

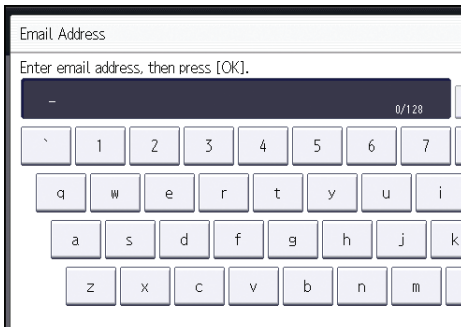

**12. Select [Email / Internet Fax Destination] or [Internet Fax Destination Only].**

If [Email / Internet Fax Destination] is specified, registered e-mail addresses appear in both Internet fax address display and e-mail address display on the fax function screen, and in the address display on the scanner function screen.

If [Internet Fax Destination Only] is specified, registered e-mail addresses only appear in Internet fax display on the fax function screen.

**13. If you want to use Internet fax, specify whether or not to use "Send via SMTP Server".****14. Press [OK].****15. Press [User Tools] (⚙️) on the top right of the screen.****16. Press [Home] (🏠) at the bottom of the screen in the center.**

---

## Changing or Deleting an E-mail Destination

---

## 5

**Changing an E-mail Destination**

1. Press [Home] (🏠) at the bottom of the screen in the center.
2. Flick the screen to the left, and then press the [Address Book Management] icon.
3. Check that [Program / Change] is selected.
4. Select the name whose e-mail address you want to change.

Press the name key, or enter the registered number using the number keys.

You can search by the registered name, user code, fax number, folder name, e-mail address, or IP-Fax destination.

5. Press [Email].
6. Press [Change] under "Email Address".

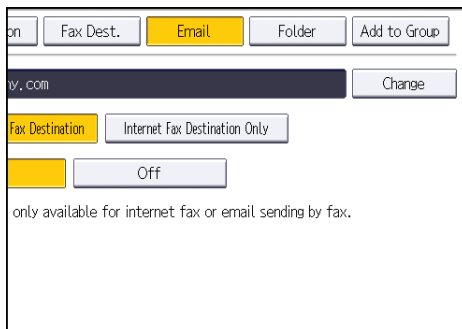

7. Enter the e-mail address, and then press [OK].
8. Press [OK].
9. Press [User Tools] (⚙️) on the top right of the screen.
10. Press [Home] (🏠) at the bottom of the screen in the center.

## Deleting an E-mail Destination

1. Press [Home] (🏠) at the bottom of the screen in the center.
2. Flick the screen to the left, and then press the [Address Book Management] icon.
3. Check that [Program / Change] is selected.
4. Select the name whose e-mail address you want to delete.  
Press the name key, or enter the registered number using the number keys.  
You can search by the registered name, user code, fax number, folder name, e-mail address, or IP-Fax destination.
5. Press [Email].
6. Press [Change] under "Email Address".
7. Press [Delete All], and then press [OK].
8. Press [OK].
9. Press [User Tools] (⚙️) on the top right of the screen.
10. Press [Home] (🏠) at the bottom of the screen in the center.

5

## Entering an E-mail Address Manually

### 📝 When Using the Scanner Application

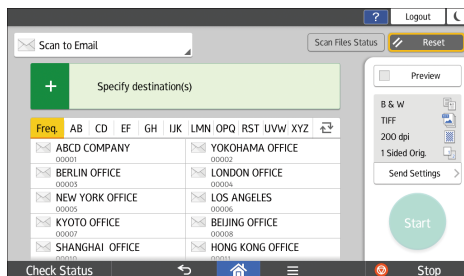

About how to use the application's screen, see page 82 "[Scanner] (standard) Screen".

## Basic Procedure for Storing Scan Files

This section explains how to store the scanned documents to the machine's hard disk.

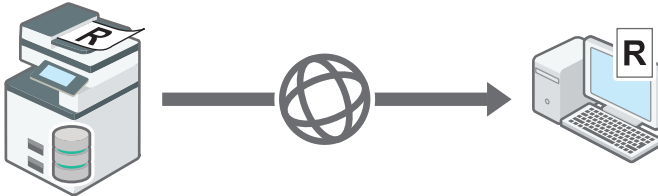

DVL860

### ★ Important

- You can specify a password for each stored file. We recommend that you protect stored files from unauthorized access by specifying passwords.
- Stored files will be deleted after a set period. For details about specifying the period, see "Administrator Tools", Settings.
- Scan file stored in the machine may be lost if some kind of failure occurs. We advise against using the hard disk to store important files. The supplier shall not be responsible for any damage that may result from the loss of files.

1. Press [Home] (🏠) at the bottom of the screen in the center.
2. Press the [Scanner (Classic)] icon.
3. Make sure that no previous settings remain.

If a previous setting remains, press [Reset].

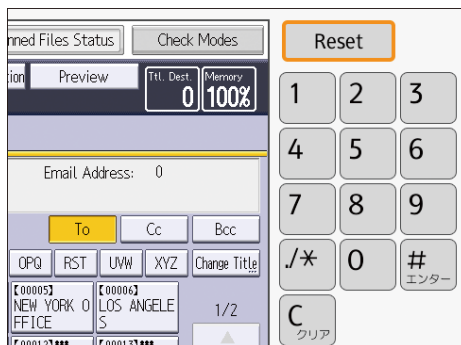

4. Place originals.

## 5. Press [Store File].

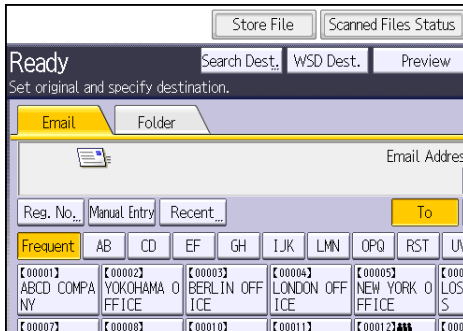

## 6. Press [Store to HDD].

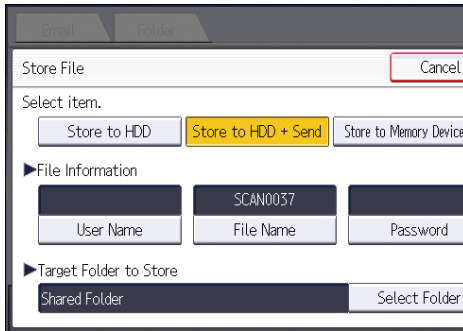

You cannot specify [Store to HDD] if [Preview] is selected.

By pressing [Store to HDD + Send], you can simultaneously store scan files and send them. For details, see "Simultaneous Storage and Sending by E-mail" and "Simultaneous Storage and Sending by Scan to Folder", Scan.

## 7. If necessary, specify the stored file's information, such as [User Name], [File Name], [Password], and [Select Folder].

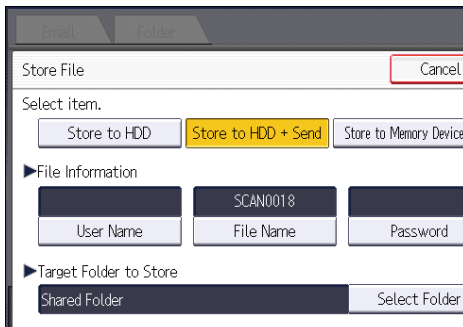

- User Name

Press [User Name], and then select a user name. To specify an unregistered user name, press [Manual Entry], and then enter the name. After specifying a user name, press [OK].

- File Name

Press [File Name], enter a file name, and then press [OK].

- Password

Press [Password], enter a password, and then press [OK]. Re-enter the password for confirmation, and then press [OK].

- Select Folder

Press [Select Folder], specify the folder in which to save the stored files, and then press [OK].

## 8. Press [OK].

## 9. If necessary, press [Scan Settings] to specify scanner settings such as resolution and scan size.



For details, see "Scan Settings", Scan.

## 10. Press [Start].

## Checking a Stored File Selected from the List

This section explains how to preview a file selected from the list of stored files.

### 1. Press [Select Stored File].

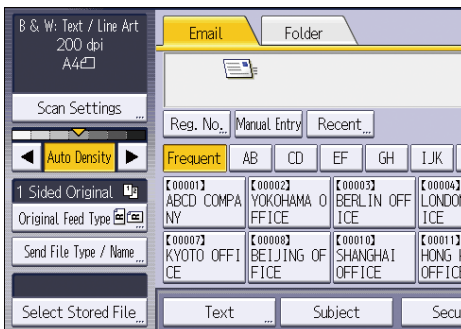

### 2. Specify the folder in which the file you want to check is stored.



**3. From the list of stored files, select the file you want to check.**

You can select more than one file.

For details about searching the stored document by user or document name, see "Searching by user name" and "Searching by file name", Scan.

**4. Press [Preview].**

## Specifying the File Type

This section explains the procedure for specifying the file type of a file you want to send.

File types can be specified when sending files by e-mail or Scan to Folder, sending stored files by e-mail or Scan to Folder, and saving files on a memory storage device.

You can select one of the following file types:

- Single Page: [TIFF / JPEG], [PDF]

If you select a single-page file type when scanning multiple originals, one file is created for each single page and the number of files sent is the same as the number of pages scanned.

- Multi-page: [TIFF], [PDF]

If you select a multi-page file type when scan multiple originals, scanned pages are combined and sent as a single file.

5

Selectable file types differ depending on the scan settings and other conditions. For details about file types, see "Notes about and limitations of file types", Scan.

### When Using the Scanner Application

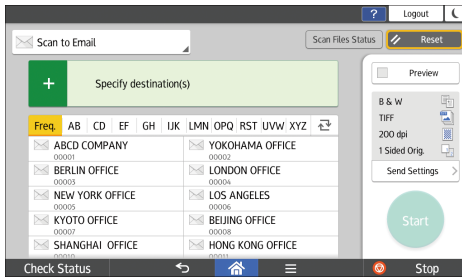

About how to use the application's screen, see page 82 "[Scanner] (standard) Screen".

# Specifying Scan Settings

## When Using the Scanner Application

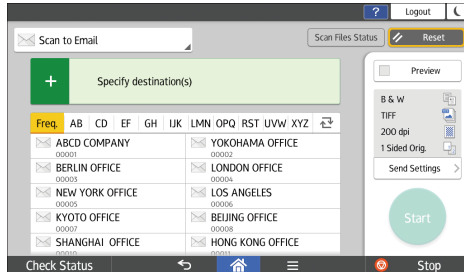

About how to use the application's screen, see page 82 "[Scanner] (standard) Screen"



# 6. Document Server

This chapter describes frequently used Document Server functions and operations. For information not included in this chapter, see Copy/ Document Server available on our website.

## Storing Data

This section describes the procedure for storing documents on the Document Server.

### ★ Important

- A document accessed with a correct password remains selected even after operations are complete, and it can be accessed by other users. After the operation, be sure to press [Reset] to cancel the document selection.
- The user name registered to a stored document in the Document Server is to identify the document creator and type. It is not to protect confidential documents from others.
- When turning on the fax transmission or scanning by the scanner, make sure that all other operations are ended.
- The Document Server can store up to 9,000 pages.

### File Name

A file name such as "COPY0001" and "COPY0002" is automatically attached to the scanned document. You can change the file name.

### User Name

You can register a user name to identify the user or user group that stored the documents. To assign it, select the user name registered in the Address Book, or enter the name directly. Depending on the security setting, [Access Privileges] may appear instead of [User Name].

For details about the Address Book, see "Registering Addresses and Users".

### Password

To prevent unauthorized printing, you can specify a password for any stored document. A protected document can only be accessed if its password is entered. If a password is specified for the documents, the lock icon appears on the left side of the file name.

1. Press [Home]  at the bottom of the screen in the center.
2. Press the [Document Server] icon.

### 3. Press [To Scanning Screen].

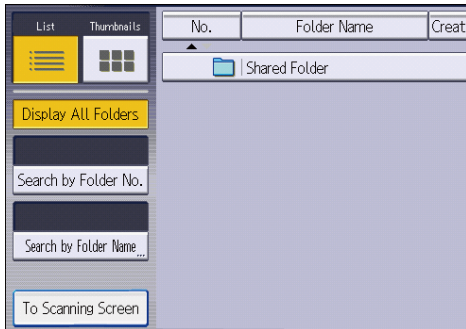

### 4. Press [Target Fldr. to Store].

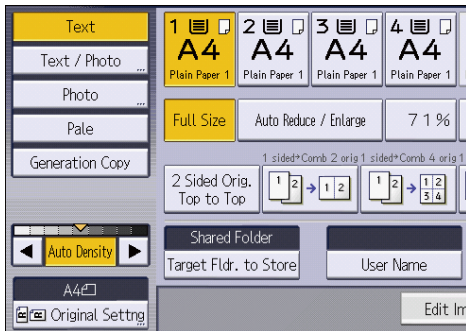

### 5. Specify a folder in which to store the document, and then press [OK].

### 6. Press [User Name].

### 7. Select a user name, and then press [OK].

The user names shown are names that were registered in the Address Book. To specify a name not shown in the screen, press [Manual Entry], and then enter a user name.

### 8. Press [File Name].

### 9. Enter a file name, and then press [OK].

### 10. Press [Password].

### 11. Enter a password with the number keys, and then press [OK].

You can use four to eight digits for the password.

### 12. For double-check, enter the password again, and then press [OK].

### 13. Place the original.

### 14. Select the paper tray.

### 15. Specify the original scanning conditions.

### 16. Press [Start].

The original is scanned. The document is saved in the Document Server.

After scanning, a list of folders will be displayed. If the list does not appear, press [Finish Scanning].

# Printing Stored Documents

Prints stored documents on the Document Server.

The items you can specify on the printing screen are as follows:

- Paper tray
- The number of prints
- [Finishing] ([Sort])
- [Cover/Slip Sheet] ([Front Cover], [Front/Back Cover], [Designate/Chapter], [Slip Sheet])
- [Edit / Stamp] ([Margin Adj.], [Stamp])
- [2 Sided Copy Top to Top], [2 Sided Copy Top to Bottom], [Booklet], [Magazine]

For details about each function, see the each section.

## 1. Select a folder.

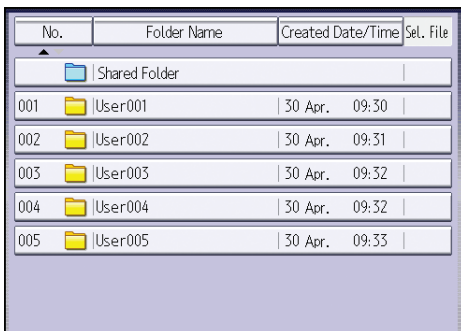

No.	Folder Name	Created Date/Time	Sel.	File
	Shared Folder			
001	User001	30 Apr. 09:30		
002	User002	30 Apr. 09:31		
003	User003	30 Apr. 09:32		
004	User004	30 Apr. 09:32		
005	User005	30 Apr. 09:33		

## 2. Select a document to be printed.

If a password is specified for the document, enter it, and then press [OK].

## 3. When printing two or more documents at a time, repeat Step 2.

Up to 30 documents can be printed.

## 4. When specifying printing conditions, press [To Printing Screen], and then configure print settings.

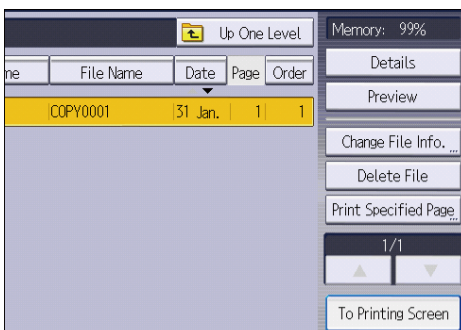



**5. Enter the number of print copies with the number keys.**

The maximum quantity that can be entered is 999.

**6. Press [Start].**

To stop printing, first press [Stop], and then press [Cancel Printing].



# 7. Web Image Monitor

This chapter describes frequently used Web Image Monitor functions and operations. For information not included in this chapter, see Connecting the Machine/ System Settings available on our website or Web Image Monitor Help.

## Displaying Top Page

This section explains the Top Page and how to display Web Image Monitor controlled from networked computers. (Web Image Monitor is a management tool installed on this machine to monitor this machine or configure settings for this machine by using a web browser.)

If user authentication is activated, you are required to enter your login user name and password to use Web Image Monitor. For Details, "Logging In/Out Using Web Image Monitor", For First-time Users.

### ★ Important

- When entering an IPv4 address, do not begin segments with zeros. For example: If the address is "192.168.001.010", you must enter it as "192.168.1.10".

1. Start a web browser from a networked computer.
2. Enter "http://(machine's IP address or host name)/" in your web browser's URL bar.

Top Page of Web Image Monitor appears.

If the machine's host name has been registered on the DNS or WINS server, you can enter it.

When setting SSL, a protocol for encrypted communication, under environment which server authentication is issued, enter "https://(machine's IP address or host name)/".

Web Image Monitor is divided into the following areas:

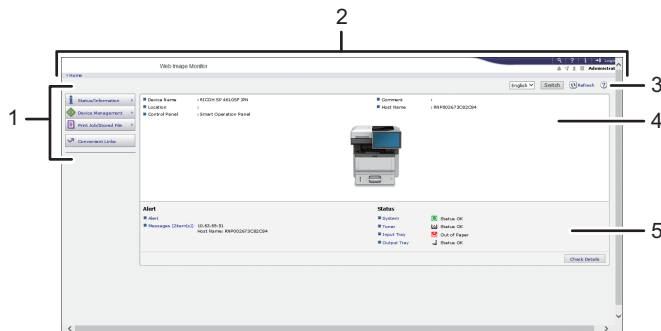

DVL845



### 1. Menu area

If you select a menu item, its content will be shown.

**2. Header area**

Display icons for the links to Help and the keyword search function. This area also displays [Login] and [Logout], which allows you to switch between the administrator and guest mode.

**3. Refresh/Help**

 (Refresh): Click  at the upper right in the work area to update the machine information. Click the web browser's [Refresh] button to refresh the entire browser screen.

 (Help): Use Help to view or download Help file contents.

**4. Basic Information area**

Display the basic information of the machine.

**5. Work area**

Display the contents of the item selected in the menu area.

# 8. Adding Paper and Toner

This chapter describes how to load paper into the paper tray and recommended paper sizes and types.

## Loading Paper

### CAUTION

- When loading paper, take care not to trap or injure your fingers.
- If one or more paper feed trays are installed, do not pull out more than one tray at a time when you are changing or replenishing paper or resolving paper jams. Pressing down forcefully on the machine's upper surfaces can result in malfunctions and/or user injury.

### Important

- Do not stack paper over the limit mark.

### Note

- If multiple sheets are fed at one time, fan the paper before loading it.
- If you load paper when only a few sheets of paper remain in the tray, multiple sheet feeding may occur. Remove any remaining paper, stack them with the new sheets of paper, and then fan the entire stack before loading it into the tray.
- Straighten curled or warped paper before loading.
- For details about the paper sizes and types that can be used, see "Recommended Paper", Specifications.
- You might at times hear a rustling noise from paper moving through the machine. This noise does not indicate a malfunction.
- If thin paper jams, decrease the amount of paper set in the tray, and then try printing again.
- When the condition of the cut edge of the paper is bad, a burr may form at the edge of the paper. When you use paper that has a burr, the orientation of the burr at the leading edge of the paper may reduce the print quality at the leading edge of the paper.

## Loading Paper into Paper Trays

Every paper tray is loaded in the same way.

In the following example procedure, paper is loaded into Tray 1.

### Important

- If a paper tray is pushed vigorously when putting it back into place, the position of the tray's side fences and end fence may slip out of place.

- When loading a low number of sheets, be sure not to squeeze the side fences and end fence in too tightly. If the side fences are squeezed too tightly against the paper, the edges may crease or the paper may misfeed.

Guide to names of paper tray

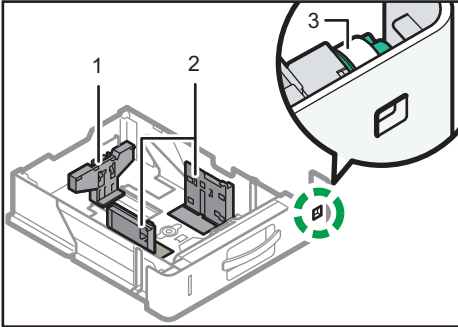

DVL540

1. End fence
2. Side fence
3. Paper size dial

1. Pull the paper tray carefully until it stops. Lift the front side of the tray, and then pull it out of the machine.

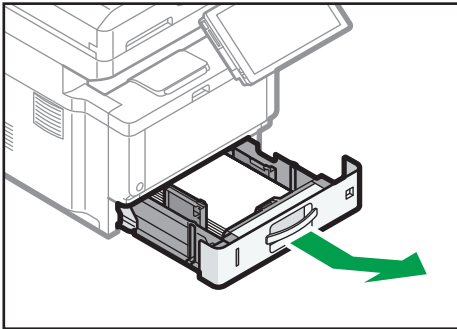

DVL415

2. Pinch the lever of the back fence and align it with the paper size. Next, pinch the lever of the right fence and align the right and left fences with the paper size.

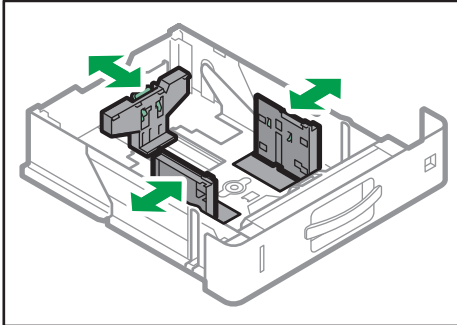

DVL402

3. Load the new paper stack print side down.

Do not stack paper over the limit mark.

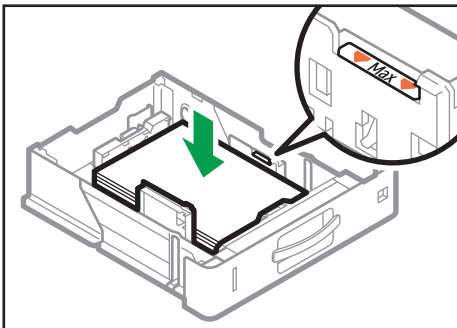

DVL403

4. Rotate the paper size dial, which is located at the front right of the tray, so that the size and the feed direction of the paper in the paper tray can be seen from the window.

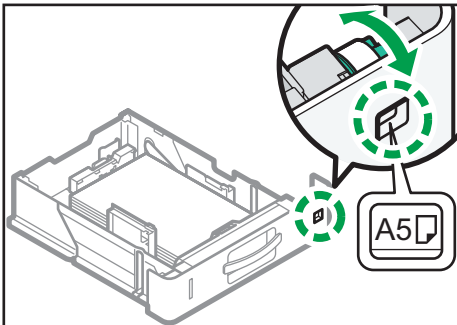

DVL401

5. Lifting the front side of the tray, insert it into the machine, and then push it in carefully until it stops.

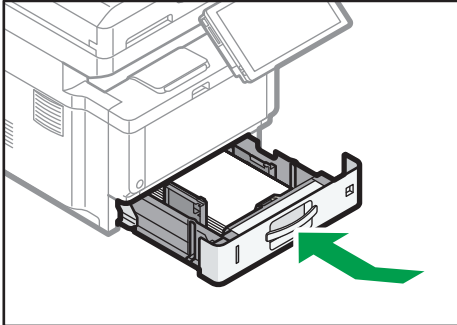

DVL405

**Note**

- While you are printing, a message informing you that the size of the paper that is loaded and the print setting are different may appear. To change the paper size, select [Job Reset] and load the correct size paper, and then try printing again. To not change the paper size, select [Loaded Paper].
- A message informing you that the size of the loaded paper and the print settings are different may appear if multiple sheets are fed at one time. If this happens, take out the loaded paper, fan it, turn it over, load it again, and then select [Loaded Paper].
- Various sizes of paper can be loaded in the paper by adjusting the positions of side fences and end fence. For details, see "Changing Paper Size Settings", For First-time Users.
- Select appropriate paper thickness for the loaded paper.
- When printing with [Thick Paper 3], remove printed sheets one by one.

---

## Loading Paper into the Bypass Tray

---

Use the bypass tray to use OHP transparencies, adhesive labels, translucent paper, and paper that cannot be loaded in the paper trays.

**★ Important**

- The maximum number of sheets you can load at the same time depends on paper type. Do not stack paper over the limit mark. For the maximum number of sheets you can load, see "Recommended Paper", Specifications.

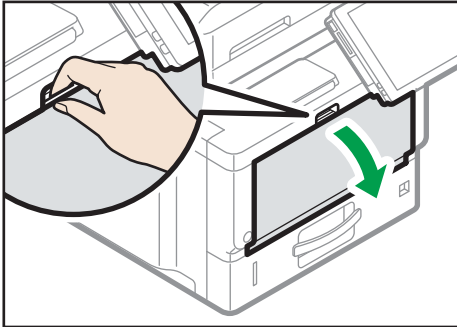

**1. Open the bypass tray.**

DVL406

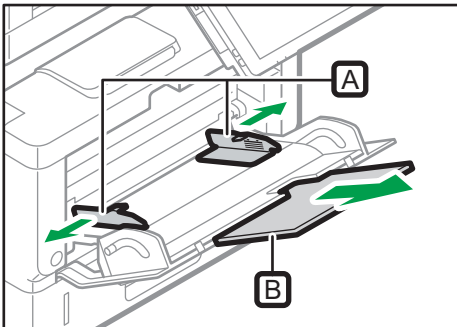
**2. Slide the paper guides **A** and the extender **B** to full size.**

DVK493

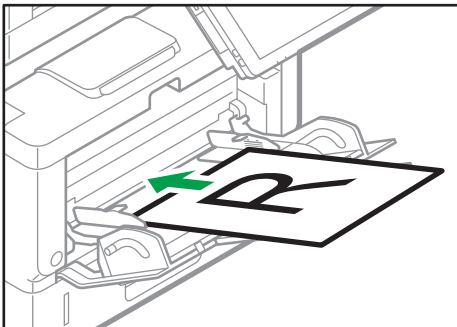
**3. Load the paper face up until you hear the beep.**

DVK494

**4. Check the paper settings and change them if necessary.****5. Align the paper guides to the paper size.**

If the guides are not flush against the paper, images might be skewed or paper misfeeds might occur.

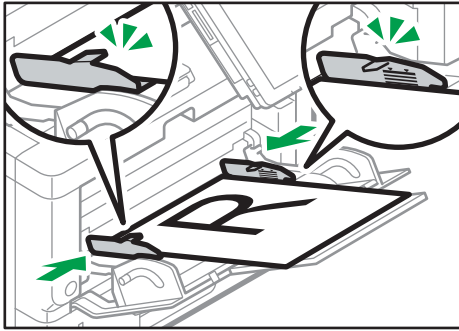

DVL409

### ↓ Note

- While you are printing, a message informing you that the size of the paper that is loaded and the print setting are different may appear. To change the paper size, select [Job Reset] and load the correct size paper, and then try printing again. To not change the paper size, select [Loaded Paper].
- A message informing you that the size of the loaded paper and the print settings are different may appear if multiple sheets are fed at one time. If this happens, take out the loaded paper, fan it, turn it over, load it again, and then select [Loaded Paper].
- When you use the bypass tray, it is recommended to load the paper so that the paper will be fed from its short edge.
- Select appropriate paper thickness for the loaded paper.
- When loading label paper:
  - It is recommended to place one sheet at a time.
  - Select the appropriate paper thickness on the screen of the bypass tray paper setting.
- When loading OHP transparencies:
  - It is recommended to place one sheet at a time.
  - When copying onto OHP transparencies, see "Copying onto OHP Transparencies", Copy/Document Server.
  - When printing on OHP transparencies from the computer, specify OHP transparencies for the paper type.
  - Fan OHP transparencies thoroughly whenever you use them. This prevents OHP transparencies from sticking together, and from feeding incorrectly.
  - Remove copied or printed sheets one by one.
- When loading translucent paper:
  - When loading translucent paper, always use long grain paper, and set the paper direction according to the grain.
  - Translucent paper easily absorbs humidity and becomes curled. Remove curl in the translucent paper before loading.

- Remove copied or printed sheets one by one.
- If a paper jam occurs or if the machine makes a strange noise when feeding stacks of coated paper, feed the coated paper from the bypass tray one sheet at a time.
- Letterhead paper must be loaded in a specific orientation. For details, see page 181 "Loading Orientation-fixed Paper or Two-sided Paper".
- You can load envelopes into the bypass tray. Envelopes must be loaded in a specific orientation. For details, see "When Loading Envelopes", Specifications.
- When copying from the bypass tray, see "Copying from the Bypass Tray", Copy/Document Server. When printing from a computer, see "Specifying Paper Type and Thickness Settings", For First-time Users.
- When [Notification Sound] is set to [No Sound], it does not sound if you load paper into the bypass tray. For details about [Notification Sound], see "Screen Features", Settings.
- When printing with [Thick Paper 3], remove printed sheets one by one.

## Loading Orientation-fixed Paper or Two-sided Paper

Orientation-fixed (top to bottom) or two-sided paper (for example, letterhead paper, punched paper, or copied paper) might not be printed correctly, depending on how the originals and paper are placed.



### Settings for the User Tools



- Copier mode  
Specify [Yes] for [Letterhead Setting] in [Input / Output] under the Copier / Document Server Features menu, and then place the original and paper as shown below.
- Printer mode  
Specify [Auto Detect] or [On (Always)] for [Letterhead Setting] in [System] under the Printer Features menu, and then place the paper as shown below.

For details about the letterhead settings, see "Input / Output", Copy/Document Server, or "System", Print.



### Original orientation and paper orientation

The meanings of the icons are as follows:

Icon	Meaning
 	Place or load paper scanned or printed side face up.

Icon	Meaning
 	Place or load paper scanned or printed side face down.

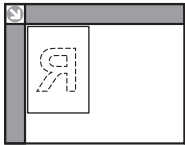
- Original orientation

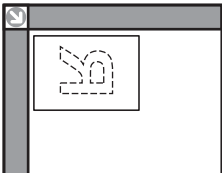
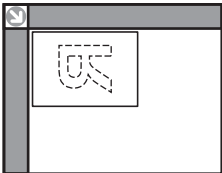
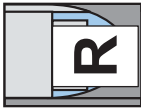
Original orientation	Exposure glass	ADF
Readable orientation (The orientation in which you can read the words when you hold the original.)		
Unreadable orientation (The orientation that the words are unreadable when you hold the original.)	<ul style="list-style-type: none"> <li>• Copy                                </li> <li>• Scanner                                </li> </ul>	

- Paper orientation
  - Copier mode

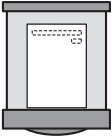
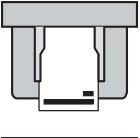
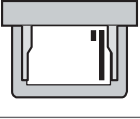
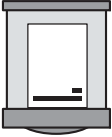
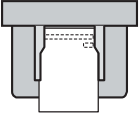
Copy side	Paper trays	Bypass tray
One-sided		 
Two-sided		

- Printer mode

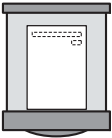
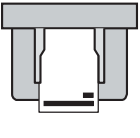
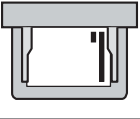
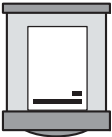
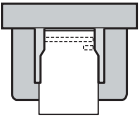
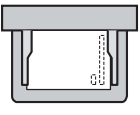
Print side	Paper trays	Bypass tray
One-sided		 
Two-sided		 

**Note**

- In copier mode:
  - For details about how to make two-sided copies, see "Duplex Copying", Copy/Document Server.
- In printer mode:
  - To print on letterhead paper when [Auto Detect] is specified for [Letterhead Setting], you must specify [Letterhead] as the paper type in the printer driver's settings.
  - If a print job is changed partway through printing from one-sided to two-sided printing, one-sided output after the first copy may be printed facing a different direction. To ensure all

paper is output facing the same direction, specify different input trays for one-sided and two-sided printing. Note also that two-sided printing must be disabled for the tray specified for one-sided printing.

- For details about how to make two-sided prints, see "Printing on Both Sides of Sheets", Print.

---

## Specifying the Paper Setting for the Bypass Tray

---

If you are using copier function, you can register the paper setting of the paper that is loaded on the bypass tray.

### ★ Important

- If you select [Machine Setting(s)] in [Bypass Tray] under [Tray Setting Priority] in [System] of the Printer Features menu, the settings made using the control panel have priority over the printer driver settings. For details, see "System", Print.
- The default of [Bypass Tray] is [Driver / Command].
- Use A4□, 8<sup>1</sup>/<sub>2</sub> × 11□ size OHP on Home screen 4 transparencies, and specify their size.
- Usually only one side of OHP transparencies can be used for printing. Be sure to load them with the print side down.
- When printing onto OHP transparencies, remove printed sheets one by one.

1. Press [Change Setting] on the bypass tray paper settings screen.

2. Select the type of paper that is loaded.

If you want to set the paper thickness, press [Paper Thickness] and set a paper thickness.

3. Press [Next].

4. Select the size of the paper that is loaded.

If you want to specify a custom size, press [Custom] and enter a paper size.

5. Press [OK] twice.

### Registering the current paper settings for the bypass tray

1. Press [Recall/Program] on the bypass tray paper settings screen.

2. Press [Program].

3. Press the name area, and then enter a name.

4. Press OK.

To apply the registered settings to the currently loaded paper, press [OK].

To finish specifying the settings, press [Cancel].

### Recalling the paper settings for the bypass tray

1. Press [Recall/Program] on the bypass tray paper settings screen.

2. Select a name of the settings to recall.
3. Press OK twice.

### Modifying the name registered for the paper settings for the bypass tray

1. Press [Recall/Program] on the bypass tray paper settings screen.
2. Select the name to modify.
3. Press [Edit], and then enter a new name.
4. Press [OK].

To apply the registered settings to the currently loaded paper, press [OK].

To finish specifying the settings, press [Cancel].

### Deleting the registered paper settings for the bypass tray

1. Press [Recall/Program] on the bypass tray paper settings screen.
2. Select the name to delete.
3. Press [Delete] on the bypass tray paper settings screen.
4. Press [Yes].

To finish specifying the settings, press [Cancel] twice.

#### Note

- If you turn the settings for bypass tray paper setting screen not to display, specify the setting from [Display Bypass Tray Paper Settings Assist] under [Tray Paper Settings] in [User Tools].
- Settings remain valid until they are changed.
- For details about setting printer drivers, see "Printing Documents", Print.
- We recommend that you use specified OHP transparencies.
- For details about paper thickness, see "Tray Paper Settings", Settings.



# Recommended Paper

This section describes recommended paper sizes and types.

## ★ Important

- If you use paper that curls, either because it is too dry or too damp, a staple clogging or paper jam may occur.
- Do not use paper designed for inkjet printers, as these may stick to the fusing unit and cause a misfeed.
- When you load OHP transparencies, check the front and back of the sheets, and place them correctly, or a misfeed might occur.

### Tray 1

Paper type and weight	Paper size	Paper capacity
52-220 g/m <sup>2</sup> (14 lb. Bond - 80 lb. Cover) Thin Paper–Thick Paper 3	Select the paper size using the paper size dial on the tray* 1: A4, A5, A6, 8 <sup>1</sup> / <sub>2</sub> × 14, 8 <sup>1</sup> / <sub>2</sub> × 11, 5 <sup>1</sup> / <sub>2</sub> × 8 <sup>1</sup> / <sub>2</sub>	550 sheets (When using Plain Paper 1)
52-220 g/m <sup>2</sup> (14 lb. Bond - 80 lb. Cover) Thin Paper–Thick Paper 3	Set the paper size dial on the tray to "Asterisk", and select the paper size with the control panel: A5, B5 JIS, B6 JIS, 8 <sup>1</sup> / <sub>2</sub> × 13, 8 <sup>1</sup> / <sub>4</sub> × 14, 8 <sup>1</sup> / <sub>4</sub> × 13, 8 × 13, 8 × 10 <sup>1</sup> / <sub>2</sub> , 8 × 10, 7 <sup>1</sup> / <sub>4</sub> × 10 <sup>1</sup> / <sub>2</sub> , 16K, 8 <sup>1</sup> / <sub>2</sub> × 13 <sup>2</sup> / <sub>5</sub>	550 sheets (When using Plain Paper 1)
52-220 g/m <sup>2</sup> (14 lb. Bond - 80 lb. Cover) Thin Paper–Thick Paper 3	Custom size:  Region A Vertical: 148.0–356.0 mm Horizontal: 82.5–216.0 mm  Region B Vertical: 5.83–14.01 inches Horizontal: 3.25–8.50 inches	550 sheets (When using Plain Paper 1)





Paper type and weight	Paper size	Paper capacity
Envelopes	Select the paper size: $4\frac{1}{8} \times 9\frac{1}{2}$ , $3\frac{7}{8} \times 7\frac{1}{2}$ , $8\frac{1}{2} \times 13\frac{2}{5}$ , C5 Env , C6 Env, DL Env	*2

\*1 When a print job is performed on A5 or  $5\frac{1}{2}'' \times 8\frac{1}{2}''$  paper, it is recommended to set the paper horizontally. While a print job is performed on paper that is loaded vertically, smearing may occur near the edges of the printed paper. Also, use the bypass tray when printing on paper that is set horizontally.

\*2 Do not stack over the limit mark. The number of sheets you can load in the paper tray varies depending on the weight and condition of the paper.



### Lower paper tray (250 sheets)

Paper type and weight	Paper size	Paper capacity
52-220 g/m <sup>2</sup> (14 lb. Bond - 80 lb. Cover) Thin Paper–Thick Paper 3	Select the paper size using the paper size dial on the tray* 1: A4, A5, A6, $8\frac{1}{2} \times 14$ , $8\frac{1}{2} \times 11$ , $5\frac{1}{2} \times 8\frac{1}{2}$	275 sheets (When using Plain Paper 1)
52-220 g/m <sup>2</sup> (14 lb. Bond - 80 lb. Cover) Thin Paper–Thick Paper 3	Set the paper size dial on the tray to "Asterisk", and select the paper size with the control panel: A5, B5 JIS, B6 JIS, $8\frac{1}{2} \times 13$ , $8\frac{1}{4} \times 14$ , $8\frac{1}{4} \times 13$ , $8 \times 13$ , $8 \times 10\frac{1}{2}$ , $8 \times 10$ , $7\frac{1}{4} \times 10\frac{1}{2}$ , 16K, $8\frac{1}{2} \times 13\frac{2}{5}$	275 sheets (When using Plain Paper 1)



Paper type and weight	Paper size	Paper capacity
52-220 g/m <sup>2</sup> (14 lb. Bond - 80 lb. Cover) Thin Paper–Thick Paper 3	Custom size:  <b>Region A</b> Vertical: 148.0–356.0 mm Horizontal: 82.5–216.0 mm  <b>Region B</b> Vertical: 5.83–14.01 inches Horizontal: 3.25–8.50 inches	275 sheets (When using Plain Paper 1)



**Lower paper tray (500 sheets)**

Paper type and weight	Paper size	Paper capacity
52-220 g/m <sup>2</sup> (14 lb. Bond - 80 lb. Cover) Thin Paper–Thick Paper 3	Select the paper size using the paper size dial on the tray*1: A4☐, A5☐, A6☐, 8 <sup>1</sup> / <sub>2</sub> × 14☐, 8 <sup>1</sup> / <sub>2</sub> × 11☐, 5 <sup>1</sup> / <sub>2</sub> × 8 <sup>1</sup> / <sub>2</sub> ☐	550 sheets (When using Plain Paper 1)
52-220 g/m <sup>2</sup> (14 lb. Bond - 80 lb. Cover) Thin Paper–Thick Paper 3	Set the paper size dial on the tray to "Asterisk", and select the paper size with the control panel: A5☐, B5 JIS☐, B6 JIS☐, 8 <sup>1</sup> / <sub>2</sub> × 13☐, 8 <sup>1</sup> / <sub>4</sub> × 14☐, 8 <sup>1</sup> / <sub>4</sub> × 13☐, 8 × 13☐, 8 × 10 <sup>1</sup> / <sub>2</sub> ☐, 8 × 10☐, 7 <sup>1</sup> / <sub>4</sub> × 10 <sup>1</sup> / <sub>2</sub> ☐, 16K☐, 8 <sup>1</sup> / <sub>2</sub> × 13 <sup>2</sup> / <sub>5</sub> ☐	550 sheets (When using Plain Paper 1)

Paper type and weight	Paper size	Paper capacity
52-220 g/m <sup>2</sup> (14 lb. Bond - 80 lb. Cover) Thin Paper–Thick Paper 3	Custom size:  <b>Region A</b> Vertical: 148.0–356.0 mm Horizontal: 82.5–216.0 mm  <b>Region B</b> Vertical: 5.83–14.01 inches Horizontal: 3.25–8.50 inches	550 sheets (When using Plain Paper 1)

### Bypass tray

Paper type and weight	Paper size	Paper capacity
52-256 g/m <sup>2</sup> (14 lb. Bond-140 lb. Index) Thin Paper-Thick Paper 3	Select the paper size <sup>*1*6</sup> : A4, A5, A6, B5 JIS, B6 JIS, B7 JIS, 8 1/2 × 14, 8 1/2 × 13, 8 1/2 × 11, 8 1/4 × 14, 8 1/4 × 13, 8 × 13, 8 × 10 1/2, 8 × 10, 7 1/4 × 10 1/2, 5 1/2 × 8 1/2, 16K, 8 1/2 × 13 2/5	<ul style="list-style-type: none"> <li>Thin Paper–Plain Paper 2: 100 sheets</li> <li>Middle Thick –Thick Paper 3: <sup>*3</sup></li> </ul>
52-256 g/m <sup>2</sup> (14 lb. Bond-140 lb. Index) Thin Paper-Thick Paper 3	Custom size <sup>*7</sup>  <b>Region A</b> Vertical: 127.0–900.0 mm Horizontal: 60.0–216.0 mm  <b>Region B</b> Vertical: 5.00–35.43 inches Horizontal: 2.37–8.50 inches	<ul style="list-style-type: none"> <li>Thin Paper–Plain Paper 2: 100 sheets</li> <li>Middle Thick –Thick Paper 3: <sup>*3</sup></li> </ul>

Paper type and weight	Paper size	Paper capacity
Translucent paper	A4, A5, A6, B5 JIS, B6 JIS, B7 JIS, 8 1/2" x 14", 8 1/2" x 13", 8 1/2" x 11", 8 1/4" x 14", 8 1/4" x 13", 8 x 13", 8 x 10 1/2", 8 x 10", 7 1/4" x 10 1/2", 5 1/2" x 8 1/2", 16K, 8 1/2" x 13 2/5"	*5
OHP transparencies		*2
Label paper (adhesive labels)	Custom size *4  <b>Region A</b> Vertical: 127.0–900.0 mm Horizontal: 60.0–216.0 mm  <b>Region B</b> Vertical: 5.00–35.43 inches Horizontal: 2.37–8.50 inches	1 sheet
Envelopes	Select the paper size: 4 1/8" x 9 1/2", 3 7/8" x 7 1/2", C5 Env, C6 Env, DL Env	*4

- \*1 When a print job is performed on A5 or 5 1/2" x 8 1/2" paper, it is recommended to load the paper horizontally. While a print job is performed on paper that is loaded vertically, smearing may occur near the edges of the printed paper.
- \*2 When loading OHP transparencies in the bypass tray, do not stack paper over the limit mark.
- \*3 When loading thick paper in the bypass tray, do not stack paper over the limit mark. The number of sheets you can load in the bypass tray varies depending on the weight and condition of the paper.
- \*4 Load envelopes so that the height of the stack of envelopes does not exceed the limit mark of the bypass tray without pressing on the stack of envelopes.
- \*5 When loading Translucent paper in the bypass tray, do not stack paper over the limit mark.
- \*6 For copier mode, see "Copying from the Bypass Tray", Copy/Document Server.
- \*7 Enter the paper size. For copier mode, see "Copying onto Custom Size Paper from the Bypass Tray", Copy/Document Server.

## Paper Thickness

Paper Thickness <sup>*1</sup>	Paper weight
Thin Paper	52–65 g/m <sup>2</sup> (14–18 lb. Bond)
Plain Paper 1	66–74 g/m <sup>2</sup> (18–20 lb. Bond)
Plain Paper 2	75–90 g/m <sup>2</sup> (20–24 lb. Bond)
Middle Thick	91–105 g/m <sup>2</sup> (24–28 lb. Bond)
Thick Paper 1	106–130 g/m <sup>2</sup> (28-35 lb. Bond)
Thick Paper 2	131–162 g/m <sup>2</sup> (35 lb. Bond–90 lb. Index)
Thick Paper 3	163–256 g/m <sup>2</sup> (90 lb. Index-140 lb. Index)

\*1 Print quality will decrease if the paper you are using is close to the minimum or maximum weight. Change the paper weight setting to thinner or thicker.

### Note

- Certain types of paper, such as translucent paper or OHP transparencies, may produce noise when delivered. This noise does not indicate a problem and print quality is unaffected.
- The paper capacity described in the tables above is an example. Actual paper capacity might be lower, depending on the paper type.
- When loading paper, make sure the stack height does not exceed the limit mark of the paper tray.
- If multiple sheet feeding occurs, fan sheets thoroughly or load sheets one by one from the bypass tray.
- Flatten out curled sheets before loading them.
- Depending on the paper sizes and types, the print speed may be slower than usual.
- When loading thick paper of 106–256 g/m<sup>2</sup> (28 lb. Bond–140 lb. Index), see page 192 "When Loading Thick Paper".
- When loading envelopes, see page 193 "When Loading Envelopes".
- When copying or printing onto letterhead paper, the paper placing orientation is different depending on which function you are using. For details, see "Loading Orientation-fixed Paper or Two-sided Paper", For First-time Users.
- If you load paper of the same size and same type in two or more trays, the machine automatically feeds from one of the trays in which [Yes] is selected for [Apply Auto Paper Select] when the first tray in use runs out of paper. This function is called Auto Tray Switching. This saves interrupting a copy run to replenish paper when making a large number of copies. You can specify the paper type of the paper trays under [Paper Type]. For details, see "Tray Paper Settings", Settings. For the

setting procedure of the Auto Tray Switching function, see "General Features", Copy/Document Server.

- When you are using 45K copy and print paper, loading the paper fully up to load limit mark (MAX mark) may cause paper jams. Load the number of sheets of paper described below, as a guide.
  - Lower paper tray (500 sheets)
    - A4☐: 500 sheets or less
    - B5☐: 500 sheets or less
    - A5☐: 250 sheets or less
  - We recommend that you use the bypass tray when you use a paper size smaller than the sizes above.
    - Lower paper tray (250 sheets)
      - A4☐: 250 sheets or less
      - B5☐: 250 sheets or less
      - A5☐: 125 sheets or less
  - We recommend that you use the bypass tray when you use a paper size smaller than the sizes above.

---

## When Loading Thick Paper

---

8



This section gives you various details about and recommendations concerning thick paper.

### CAUTION

- When loading thick paper of 106–256 g/m<sup>2</sup> (28 lb. Bond–68 lb. Index) in the paper trays or bypass tray, follow the recommendations below to prevent misfeeds and loss of image quality.

When loading thick paper of 106–163 g/m<sup>2</sup> (28 lb. Bond–90 lb. Index) in the paper trays, or 106–220 g/m<sup>2</sup> (28 lb. Bond–80 lb. Cover) in the bypass tray, follow the recommendations below to prevent misfeeds and loss of image quality.

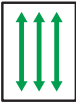
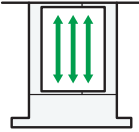
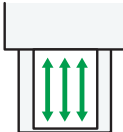
- Store all your paper in the same environment - a room where the temperature is 20–25°C (68–77°F) and the humidity is 30–65%.
- Jams and misfeeds can occur when printing on thick smooth paper. To prevent such problems, be sure to fan smooth paper thoroughly before loading them. If paper continues to become jammed or feed in together even after they are fanned, load them one by one from the bypass tray.
- When loading thick paper, set the paper direction according to its grain, as shown in the following diagram:

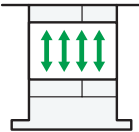
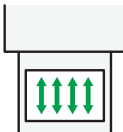
Direction of paper grain	Paper trays	Bypass tray
		
		

### ↓ Note

- Select [Thick Paper 1] or [Thick Paper 2] as the paper thickness in [Tray Paper Settings].
- If Thin Paper, Thick Paper 1 (when in low temperature), Thick Paper 2, or Thick Paper 3 is selected, the print speed may change.
- Even if thick paper is loaded as described above, normal operations and print quality might still not be possible, depending on the paper type.
- Prints might have prominent vertical creases.
- Prints might be noticeably curled. Flatten out prints if they are creased or curled.
- When printing onto thick paper, the print speed changes.

## When Loading Envelopes

This section gives you various details about and recommendations concerning envelopes.

### ★ Important

- Do not use window envelopes.
- Fan the envelopes before loading them to separate them and prevent the glue on them from causing them to stick together. If fanning does not prevent them sticking together, load them one by one. Note that some types of envelopes cannot be used with this machine.
- Some kinds of envelope might cause misfeeds, wrinkles or print poorly.
- When loading envelopes in the □ orientation, load them with flaps closed.
- Before loading envelopes, press down on them to remove any air from inside, flatten out all four edges. If they are bent or curled, flatten their leading edges (the edge going into the machine) by running a pencil or ruler across them.
- When loading envelopes, do not stack paper over the limit mark. If you squeeze extra envelopes into the bypass tray, misfeeds might occur.

**In copier mode**

The way to load envelopes varies depending on the orientation of the envelopes. When copying onto envelopes, load them according to the applicable orientation shown below:

**How to load envelopes**

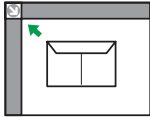
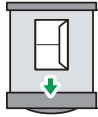
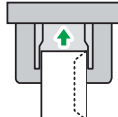

Orientation of envelopes	Exposure glass	Tray 1	Bypass tray
Side-opening envelopes 	 <ul style="list-style-type: none"> <li>• Flaps: closed</li> <li>• Bottom side of envelopes: toward the front of the machine</li> <li>• Side to be scanned: face down</li> </ul>	 <ul style="list-style-type: none"> <li>• Flaps: closed</li> <li>• Bottom side of envelopes: toward the left of the machine</li> <li>• Side to be printed: face down</li> </ul>	 <ul style="list-style-type: none"> <li>• Flaps: closed</li> <li>• Bottom side of envelopes: toward the left of the machine</li> <li>• Side to be printed: face up</li> </ul>

When loading envelopes, specify the envelope size and thickness. For details, see "Copying onto Envelopes", Copy/Document Server.

**In printer mode**

The way to load envelopes varies depending on the orientation of the envelopes. When printing onto envelopes, load them according to the applicable orientation shown below:

**How to load envelopes**

Types of envelopes	Tray 1	Bypass tray
Side-opening envelopes 	 <ul style="list-style-type: none"> <li>• Flaps: closed</li> <li>• Bottom side of envelopes: toward the left of the machine</li> <li>• Side to be printed: face down</li> </ul>	 <ul style="list-style-type: none"> <li>• Flaps: closed</li> <li>• Bottom side of envelopes: toward the left of the machine</li> <li>• Side to be printed: face up</li> </ul>



When loading envelopes, select "Envelope" as the paper types using both [Tray Paper Settings] and printer driver and specify the thickness of envelopes. For details, see "Printing on Envelopes", Print.

To print on envelopes that are loaded with their short edges against the machine body, images may not be printed appropriately. Change settings according to the function you use. Be sure to set the original and paper appropriately.

To print on envelopes that are loaded with their short edges against the machine body, rotate the print image by 180 degrees using the printer driver.

### Recommended envelopes

For information about recommended envelopes, contact your local dealer.

For details about the sizes of envelopes you can load, see page 186 "Recommended Paper".

#### Note

- Load only one size and type of envelope at a time.
- The Duplex function cannot be used with envelopes.
- To get better output quality, it is recommended that you set the leading-edge print margin to at least 15 mm (0.6 inches) and the other margins to at least 10 mm (0.4 inches) each.
- Output quality on envelopes may be uneven if parts of an envelope have differing thicknesses. Print one or two envelopes to check print quality.
- Flatten out prints if they are creased or curled.
- Check the envelopes are not damp.
- High temperature and high humidity conditions can reduce print quality and cause envelopes to become creased.
- Depending on the environment, envelopes may wrinkle them even if they are recommended.
- Certain types of envelopes might come out creased, dirtied, or misprinted. If you are printing a solid color on an envelope, lines may appear where the overlapped edges of the envelope make it thicker.
- When you print on envelope, the print speed may be slower than usual.

# Adding Toner

This section explains precautions when replacing the print cartridge, procedures for replacing the print cartridge, operations when toner has run out, and how to dispose of used print cartridge.

## **WARNING**

- Do not dispose of the following items into a fire. Toner will ignite on contact with naked flame and burns can result.

- Toner (new or used)
- Toner containers while toner is inside
- Toner-attached parts

- Do not store toner (new or used) or toner containers while toner is inside in a place with an open flame. The toner can ignite and result in burns or fire.

- Do not absorb spilled toner (including used toner) using a vacuum cleaner. Absorbed toner may cause ignition or explosion due to electric contact sparks inside the vacuum cleaner. However, you can use a toner-compatible industrial vacuum cleaner. When toner is spilled, remove the spilled toner using a wet cloth so that the toner is not scattered.

- The following explains the warning messages on the plastic bag used in this product's packaging:

- Do not leave the polythene materials (bags, etc.) supplied with this machine close to babies and small children. Suffocation can result if polythene materials are brought into contact with the mouth or nose.

## **CAUTION**

- Do not open toner containers forcibly while toner is inside, crush or squeeze them. Toner spillage can cause accidental ingestion or dirtying of clothes, hands, or floor.

- Do not leave the following items in a place where children can reach them:

- Toner (new or used)
- Toner containers while toner is inside
- Toner-attached parts

**⚠ CAUTION**

- When the following occurs while toner is handled, receive emergency measures first, and then consult a doctor if necessary.
  - When inhaling toner, gargle with a large amount of water and move into a fresh air environment.
  - When swallowing toner, dilute gastric contents with a large amount of water.
  - When getting toner into your eyes, flush them with a large amount of water.
- When removing jammed paper, replenishing or replacing toner (new or used), be careful not to have toner dirt your skin or clothes.
- If toner (new or used) comes into contact with your skin or clothes and smears them, take the following actions:
  - If toner comes into contact with your skin, wash the affected area thoroughly with soap and water.
  - If toner comes into contact with your clothes, wash the stained area with cold water. Heating the stained area by applying hot water will set the toner into the fabric and removing the stain may become impossible.
- When replacing a container with toner (including used toner) or consumables with toner, be careful that the toner does not splatter. After removing used consumables and shutting the lid of the container if the lid is available, put them in a bag.

**★ Important**

- Always replace the print cartridge when a notification appears on the machine.
- Fault may occur if you use toner other than the recommended type.
- When adding toner, do not turn off the main power. If you do, settings will be lost.
- Store print cartridges where it will not be exposed to direct sunlight, temperatures above 35°C (95°F), or humidity over 70%.
- Store print cartridges horizontally.
- Do not repeatedly install and remove print cartridges. This will result in toner leakage.
- Do not shake print cartridges.
- Do not touch the part illustrated below.

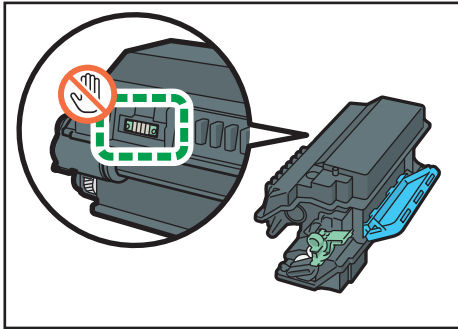

- Close all paper trays and optional paper feed units before opening the front cover.

---

## Faxing/Scanning Operations When Toner Has Run Out

---

When the machine has run out of toner, the indicator on the display lights. Note that even if there is no toner left, you can still send faxes or scanned documents.

### ★ Important

- If number of communications executed after the toner has run out and not listed in the automatically output Record exceeds 200, communication is not possible.

1. Press [Home]  at the bottom of the screen in the center.
2. Press the [Fax] icon or the [Scanner] icon.
3. Press [Exit], and then perform transmission operation.

The error message disappears.

### ↓ Note

- Any reports are not printed.

---

## Disposing of Used Print Cartridge

---

This section describes what to do with used print cartridges.

Print cartridges cannot be re-used.

Pack used print cartridges in a box or a bag to prevent the toner from leaking out of the container when you dispose of it.

 **Region A** (mainly Europe and Asia)

If you want to discard your used print cartridge, please contact your local sales office. If you discard it by yourself, treat it as general plastic waste material.

 **Region B** (mainly North America)

Please see our local company website for information on the recycling of supply products, or you can recycle items according to the requirements of your local municipalities or private recyclers.









# 9. Troubleshooting

This chapter describes basic troubleshooting procedures.

## When a Status Icon Is Displayed on the Control Panel

This section describes the status icons displayed when the machine requires the user to remove misfed paper, to add paper, or to perform other procedures.

Status Icon	Status
 : Paper Misfeed icon	Appears when a paper misfeed occurs. For details about removing jammed paper, see "Removing Jammed Paper", Troubleshooting.
 : Original Misfeed icon	Appears when an original misfeed occurs. For details about removing jammed paper, see "Removing Jammed Paper", Troubleshooting.
 : Load Paper icon	Appears when paper runs out. For details about loading paper, see "Loading Paper", For First-time Users.
 : Add Toner icon	Appears when toner runs out. For details about adding toner, see "Adding Toner", Maintenance.
 : Service Call icon	Appears when the machine is malfunctioning or requires maintenance.
 : Open Cover icon	Appears when one or more covers of the machine are open.

# When the Indicator Lamp for [Check Status] Is Lit or Flashing

If the indicator lamp for [Check Status] lights up or flashes, press [Check Status] to display the [Check Status] screen. Check the status of each function in the [Check Status] screen.

[Check Status] screen

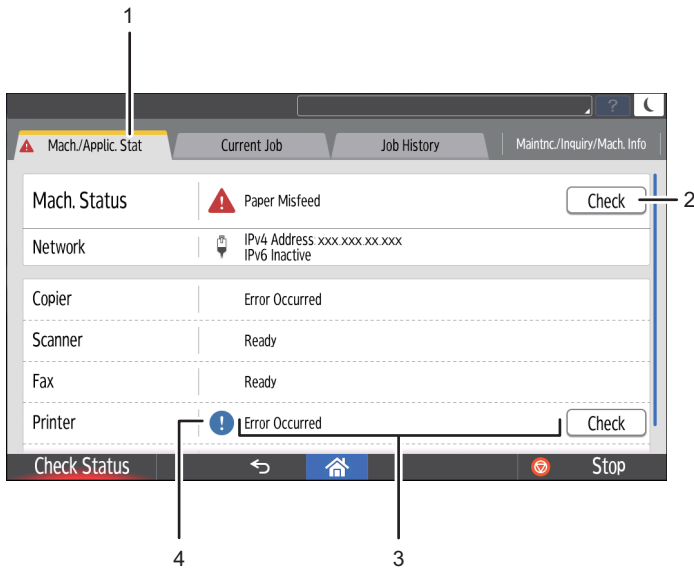

DVL531

## 1. [Mach./Applic. Stat] tab

Indicates the status of the machine and each function.

## 2. [Check]

If an error occurs in the machine or a function, or if you want to confirm the current status of the network connection of the machine, press [Check] to view details.

Pressing [Check] displays an error message or the corresponding function screen. Check the error message displayed on the function screen and take the appropriate action. For details about how to resolve the problems described in error messages, see "When Messages Appear", Troubleshooting.

## 3. Messages

Displays a message that indicates the status of the machine and each function.

## 4. Status icons

The status icons that can be displayed are described below:

: The function is performing a job.

: The machine cannot be used because an error has occurred in the machine.

: The function cannot be used because an error has occurred in the function or machine. This icon may also appear if the toner is running low.



The following table explains problems that cause the indicator lamp for [Check Status] to light or flash.

Problem	Cause	Solution
Documents and reports do not print out.	The paper output tray is full.	Remove the prints from the tray.
Documents and reports do not print out.	There is no paper left.	Load paper. For details about loading paper, see "Loading Paper", For First-time Users.
An error has occurred.	A function which has the status "Error Occurred" in the [Check Status] screen is defective.	Press [Check] in the function which the error has occurred. Then read the displayed message, and take the appropriate action. For details about error messages and their solutions, see "When Messages Appear", Troubleshooting. You can use other functions normally.
The machine is unable to connect to the network.	A network error has occurred.	<ul style="list-style-type: none"> <li>• Check that the machine is correctly connected to the network and that the machine is correctly set. For details about how to connect the network, see "Connecting to the Interface", Settings.</li> <li>• For details about connecting to the network, contact your administrator.</li> <li>• If the indicator lamp is still lit even after you try to solve the problem as described here, contact your service representative.</li> </ul>

## When the Machine Makes a Beeping Sound

The machine beeps in various patterns to alert users that they have forgotten their originals or other situations with the machine. The following table describes the meaning of the various beep patterns that are set as the defaults.

Beep pattern	Meaning	Cause
Single short beep	Panel/screen input accepted. A login or logout was complete.	A screen key was pressed. A user was logged in or logged out.
Short, then long beep	Panel/screen input rejected.	An invalid key was pressed on the screen, or the entered password was incorrect.
Single long beep	Job completed successfully.	A job (such as printing or scanning) completed successfully.
2 long beeps	Machine has warmed up.	When the power is turned on or the machine exits sleep mode, the machine has fully warmed up and is ready for use.
5 long beeps	Soft alert	An auto reset was performed through the simple screen of the copier/ Document Server function, the fax function, or the scanner function.
5 long beeps repeated four times.	Soft alert	An original has been left on the exposure glass or the paper tray is empty.
5 short beeps repeated five times.	Strong alert	The machine requires user attention because paper has jammed, the toner needs replenishing, or other problems have occurred.
12 short beeps	A blank page was detected.	The first page of the scanned original was blank or nearly blank when you used the fax function or the scanner function.

 **Note**

- Users cannot mute the machine's sound. When the machine makes a sound to alert users of a paper jam or toner request, if the machine's covers are opened and closed repeatedly within a short space of time, the sound might continue, even after normal status has resumed.
- You can specify the sound pattern, and enable or disable the sound. For details about sound, see "DEVICE", Settings.

## When You Have Problems Operating the Machine

Problem	Cause	Solution
When the machine is turned on, the only icon that appears on the home screen is the [Copier] icon.	Functions other than the copier function are not yet ready.	Wait a little longer.
The machine has just been turned on and the User Tools screen is displayed, but the User Tools menu has items missing.	Functions other than the copier function are not yet ready. Time required varies by function. Functions appear in the User Tools menu when they become ready for use.	Wait a little longer.
Help is not displayed when you press [Help] (■?).	The application that is currently in use does not support the help function, or ■? is grayed out because "Paper Misfeed" or another message is being displayed.	The help function cannot be used when ■? is grayed out. Close the application or message, and then try again.
	■? is grayed out because the user does not have permission to use the browser function.	The help function cannot be used if the user does not have permission to use the browser function. If ■? is always grayed out, consult the user administrator to check whether you have permission to use the browser function. The user administrator can change the access permissions in the address book.  For details about functions that users can use, see "Confirming the Available Functions", For First-time Users.

Problem	Cause	Solution
The screen changes to Web Browser when you press [Help] ( ? ), but the help content is not displayed.	The machine is not connected to the network correctly.	Check if you can display a web page in [Web Browser]. If a web page cannot be displayed, check that the machine is connected to the network correctly.  For how to connect to the network, see "Connecting and Setting the Network", Setup.
	The browser is configured not to save cookies.	Press [Menu] (☰) in [Web Browser], and then select [Settings]. Confirm that [Accept cookies] in [Privacy & security] is set to [ON].
The indicator lamp remains lit and the machine does not enter Sleep mode even though [Energy Saver] was pressed.	In some cases, the machine does not enter Sleep mode when [Energy Saver] is pressed.	Before you press [Energy Saver], check that Sleep mode can be enabled. For details about enabling Sleep mode, see "Saving Energy", For First-time Users.
The display is turned off.	The machine is in Sleep mode.	Touch the display panel.
Nothing happens when the display panel is touched.	The power is turned off.	Make sure the main power indicator is off, and then turn on the power.
The power turns off automatically.	The Weekly Timer setting is set to [Main Power Off].	Change the Weekly Timer setting. For details about the Weekly Timer setting, see "Timer Settings", Settings.
The user code entry screen is displayed.	Users are restricted by User Code Authentication.	For details about how to log in when User Code Authentication is enabled, see "When the Authentication Screen is Displayed", For First-time Users.
The Authentication screen appears.	User Authentication is set.	See "When the Authentication Screen is Displayed", For First-time Users.

Problem	Cause	Solution
An error message is still displayed, even if misfed paper is removed.	Paper is still jammed in the tray.	Remove the jammed paper by following the procedures displayed on the control panel. For details about removing jammed paper, see "Removing Jammed Paper", Troubleshooting.
An error message is still displayed, even if the indicated cover is closed.	One or more of the covers that are not indicated are still open.	Close all the covers of the machine.
Images are printed on the reverse side of the paper.	You may have loaded the paper incorrectly.	Load the paper correctly. For details about loading paper, see "Loading Paper", For First-time Users.
Misfeeds occur frequently.	Using curled paper often causes misfeeds, soiled paper edges, or slipped positions while stack printing is performed.	<ul style="list-style-type: none"> <li>• Flatten the paper with your hands to straighten out the curl.</li> <li>• Load the paper up side down so that the curled edges face downward. Do not change the loading direction of the paper. For details about recommended paper, see "Recommended Paper", Specifications.</li> <li>• Place the cut paper on a flat surface to prevent it from curling, and do not lean it against the wall. For details about the proper way to store paper, see "Paper Storage", Specifications.</li> </ul>
Misfeeds occur frequently.	The tray's side or end fences may not be set properly.	<ul style="list-style-type: none"> <li>• Remove the misfed paper. For details about removing jammed paper, see "Removing Jammed Paper", Troubleshooting.</li> <li>• Check that the side or end fences are set properly. Also, check that the side fences are locked. For details about setting the side and end fences, see "Changing the Paper Size", For First-time Users.</li> </ul>

Problem	Cause	Solution
Misfeeds occur frequently.	Copy paper size setting is not correct.	Remove the misfed paper. For details about removing jammed paper, see "Removing Jammed Paper", Troubleshooting.
Misfeeds occur frequently.	There is a foreign object on the output tray.	<ul style="list-style-type: none"> <li>Remove the misfed paper. For details about removing jammed paper, see "Removing Jammed Paper", Troubleshooting.</li> <li>Do not place anything on the output tray.</li> </ul>
Misfeeds occur frequently.	Non-recommended paper is being used. For example, 256 g/m <sup>2</sup> paper is loaded in the paper tray.	Use the recommended paper. For details about recommended paper, see "Recommended Paper", Specifications.
Misfeeds occur frequently.	The paper size that is set by the paper size dial on the paper tray differs from the paper size that is loaded in the paper tray.	<ul style="list-style-type: none"> <li>Use the recommended paper. For details about recommended paper, see "Recommended Paper", Specifications.</li> <li>Set the paper size dial on the tray correctly. For details, see "Changing the Paper Size", For First-time Users.</li> </ul>
Misfeeds occur when printing to envelopes.	The envelopes are curled.	Make sure you fully flatten curled envelopes before you load them. Do not stack envelopes over the specified limit for the paper tray. If misfeeds still occur after the envelopes have been flattened, load envelopes on the tray one at a time and print them individually. For details about how to load envelopes, see "When Loading Envelopes", Specifications.

Problem	Cause	Solution
When printing to envelopes, the envelopes may be fed in together, or the envelopes may not be fed.	The envelopes are curled.	Make sure you fully flatten curled envelopes before you load them. Do not stack envelopes over the specified limit for the paper tray. If misfeeds still occur after the envelopes have been flattened, load envelopes on the tray one at a time and print them individually. For details about how to load envelopes, see "When Loading Envelopes", Specifications.
Cannot print in duplex mode.	You have selected a paper tray that is not set for duplex printing.	Change the setting for "Apply Duplex" in "Tray Paper Settings" to enable duplex printing for the paper tray. For details about setting "Apply Duplex", see "Tray Paper Settings", Settings.
Cannot print in duplex mode.	You have selected a paper type that cannot be used for duplex printing.	In "Tray Paper Settings", select a paper type that can be used for duplex printing. For details about setting "Paper Type", see "Tray Paper Settings", Settings.
The machine does not turn off in 2 minutes after the main power is turned off.	The machine cannot perform the shutdown procedure.	Repeat the shutdown procedure. If the machine does not turn off, contact your service representative.
An error has occurred when the address book is changed by using the display panel or a web browser on a networked computer. (When using a web browser, you are using Web Image Monitor, which is installed on the machine.)	The address book cannot be changed while you delete the multiple stored documents.	Wait a while, and then retry the operation.



Problem	Cause	Solution
The address book cannot be changed from the display panel.	The address book cannot be changed while it is being backed up using a web browser or other tools on a networked computer.	<ul style="list-style-type: none"> <li>• Wait until the address book backup is complete, and then try to change the address book again.</li> <li>• If an SC997 error occurs, press [Exit].</li> </ul>
By using a web browser on a networked computer, you cannot print documents stored in Document Server. (You are using Web Image Monitor, which is installed on the machine.)	When print volume limits are specified, users cannot print beyond their print volume limit. Print jobs selected by users who have reached their print volume limits will be canceled.	<ul style="list-style-type: none"> <li>• For details about specifying print volume limits, see "Managing Print Volume per User", Security.</li> <li>• To view the status of a print job, see [Print Job History]. In Web Image Monitor, click [Job] on the [Status/Information] menu. And then click [Print Job History] in "Document Server". For details about displaying Web Image Monitor, see "Using a Web Browser", Settings. For details about using Web Image Monitor, see Web Image Monitor Help.</li> </ul>
The function does not run or cannot be used.	If you cannot carry out your job, it may be that the machine is being used by another function.	<p>Wait until the current job is completed before trying again.</p> <p>For details about Function Compatibility, see "When Multiple Functions Cannot Be Executed Simultaneously", Troubleshooting.</p>
The function does not run or cannot be used.	The function cannot be performed while the address book is being backed up from a web browser or other tools on a networked computer.	Wait a while. When the address book backup is complete, the function will be performed.

Problem	Cause	Solution
<p>The print image is not properly positioned on the paper.</p>	<ul style="list-style-type: none"> <li>• The machine has not detected the paper type and/or width correctly.</li> <li>• The print position is not aligned properly.</li> </ul>	<p>Contact the machine administrator or your service representative.</p>

**Note**

- There are times when images might not turn out as you want because of paper type, paper size, or paper capacity problems. Use the recommended paper. For details about recommended paper, see "Recommended Paper", Specifications.

---

### When Multiple Functions Cannot Be Executed Simultaneously

---

If you cannot carry out your job, it may be that the machine is being used by another function.

Wait until the current job is completed before trying again. In certain cases, you can carry out another job using a different function while the current job is being performed.

For details about Function Compatibility, see "Function Compatibility", Copy/Document Server.

# Messages Displayed When You Use the Copy/Document Server Function

## ★ Important

- If you cannot make copies as you want because of the paper type, paper size or paper capacity problems, use recommended paper. For details about recommended paper, see "Recommended Paper", Specifications.

Message	Cause	Solution
"Cannot delete the folder because it contains files with passwords. Delete the files with passwords, or please contact the file administrator."	The folder cannot be deleted because it contains a locked original.	Unlock the locked original to delete it. For details about locked files, see "Managing Stored Files", Security.
"Cannot display preview of this page."	The image data may have been corrupted.	Press [Exit] to display the preview screen without a thumbnail.  If the selected document contains several pages, press [Switch] on the "Display Page" area to change the page, and then a preview of the next page will appear.
"Check paper size."	An irregular paper size is set.	If you press [Start], the copy will start using the selected paper.
"Exceeded the maximum number of sheets that can be used. Copying will be stopped."	The number of pages the user is permitted to copy has been exceeded.	For details about how to check the number of copies available per user, see "Managing Print Volume per User", Security.
"File being stored exceeded max. number of pages per file. Copying will be stopped."	The scanned originals have too many pages to store as one document.	Press [Exit], and then store again with an appropriate number of pages.

Message	Cause	Solution
"Maximum number of sets is n." ("n" is replaced by a variable.)	The number of copies exceeds the maximum copy quantity.	You can change the maximum copy quantity from [Max. Copy Quantity] in [General Features] under [Copier / Document Server Features]. For details about Max. Copy Quantity, see "General Features", Copy/Document Server.
"Memory is full. n originals have been scanned. Press [Print] to copy scanned originals. Do not remove remaining originals." ("n" is replaced by a variable.)	The number of scanned originals exceed the number of pages that can be stored in memory.	Press [Print] to copy scanned originals and cancel the scanning data. Press [Clear Memory] to cancel the scanning data and not copy.
"Press [Continue] to scan and copy remaining originals."	The machine checked if the remaining originals should be copied, after the scanned originals were printed.	Remove all copies, and then press [Continue] to continue copying. Press [Stop] to stop copying.
"The selected folder is locked. Please contact the file administrator."	An attempt was made to edit or use a locked folder.	For details about locked folders, see "Managing Folders", Security.

 **Note**

- If you set [Memory Full Auto Scan Restart] in [Input / Output] of User Tools to [On], even if the memory becomes full, the memory overflow message will not be displayed. The machine will make copies of the scanned originals first, and then automatically proceed to scan and to copy the remaining originals. In this case, the resulting sorted pages will not be sequential. For details about Memory Full Auto Scan Restart, see "Input / Output", Copy/Document Server.

# Messages Displayed When You Use the Fax Function

Message	Cause	Solution
"Cannot find the specified path. Please check the settings."	The name of the computer or folder entered as the destination is wrong.	Check that the computer name and the folder name for the destination are correct.
"Error occurred, and transmission was cancelled."	<ul style="list-style-type: none"> <li>• Original jammed during Immediate Transmission.</li> <li>• A problem occurred in the machine, or noise occurred on the telephone line.</li> </ul>	Press [Exit], and then send the documents again.
"Functional problem occurred. Stopped processing."	The power was turned off while the machine was receiving a document by Internet Fax.	Even if you turn on the power immediately, depending on the mail server, the machine might not be able to resume receiving the Internet Fax if the timeout period has not expired. Wait until the mail server's timeout period has expired, and then resume receiving the Internet Fax. For details about receiving the Internet Fax, contact your administrator.
"Functional problems with fax. Data will be initialized."	There is a problem with the fax.	Record the code number shown on the screen, and then contact your service representative. Other functions can be used.
"Memory is full. Cannot scan more. Transmission will be stopped."	The memory is full.	<p>If you press [Exit], the machine returns to standby mode and starts transmitting the stored pages.</p> <p>Check the pages that have not been sent using the Communication Result Report, and then resend those pages.</p>
"Put original back, check it and press the Start key."	Original jammed during Memory Transmission.	Press [Exit], and then send the documents again.

Message	Cause	Solution
"Some page(s) are near blank."	The first page of the document is almost blank.	The original's blank side might have been scanned. Be sure to place your originals correctly. For details about determining the cause of blank pages, see "Detecting Blank Pages", Fax.

**When fax network setting problems occur**

Message	Cause	Solution
"Check whether there are any network problems." [13-10]	The alias telephone number you entered is already registered on the gatekeeper by another device.	<ul style="list-style-type: none"> <li>• Check that the correct alias phone number is listed in [H.323 Settings] of [Fax Features]. For details about H.323 Settings, see "Initial Settings", Fax.</li> <li>• For details about network problems, contact your administrator.</li> </ul>
"Check whether there are any network problems." [13-11]	Cannot access gatekeeper.	<ul style="list-style-type: none"> <li>• Check that the correct gatekeeper address is listed in [H.323 Settings] of [Fax Features]. For details about H.323 Settings, see "Initial Settings", Fax.</li> <li>• For details about network problems, contact your administrator.</li> </ul>
"Check whether there are any network problems." [13-17]	User name registration is refused by SIP server.	<ul style="list-style-type: none"> <li>• Correct that the correct SIP Server IP Address and SIP User Name are listed in [SIP Settings] of [Fax Features]. For details about SIP Settings, see "Initial Settings", Fax.</li> <li>• For details about network problems, contact your administrator.</li> </ul>

Message	Cause	Solution
"Check whether there are any network problems." [13-18]	Cannot access SIP server.	<ul style="list-style-type: none"> <li>• Check that the correct SIP Server IP Address is listed in [SIP Settings] of [Fax Features]. For details about SIP Settings, see "Initial Settings", Fax.</li> <li>• For details about network problems, contact your administrator.</li> </ul>
"Check whether there are any network problems." [13-24]	The password registered for the SIP server is not the same as the password registered for this machine.	For details about network problems, contact your administrator.
"Check whether there are any network problems." [13-25]	In [Effective Protocol], the IP address is not enabled, or an incorrect IP address has been registered.	<ul style="list-style-type: none"> <li>• Check that IPv4 in [Effective Protocol] is set to "Active" in [System Settings]. For details about effective protocol, see "Interface Settings", Connecting the Machine/ System Settings.</li> <li>• Check that the correct IPv4 address is specified for the machine in [System Settings]. For details about IPv4 address, see "Interface Settings", Settings.</li> <li>• For details about network problems, contact your administrator.</li> </ul>
"Check whether there are any network problems." [13-26]	The "Effective Protocol" and "SIP Server IP Address" settings are different, or an incorrect IP address has been registered.	<ul style="list-style-type: none"> <li>• Check that the correct IP address is specified for the machine in [System Settings]. For details about IP address, see "Interface Settings", Settings.</li> <li>• For details about network problems, contact your administrator.</li> </ul>

Message	Cause	Solution
<p>"Check whether there are any network problems." [14-01]</p>	<p>The DNS server, SMTP server, or folder specified for transfer to was not found, or the destination for Internet Fax around (not through) the SMTP server could not be found.</p>	<ul style="list-style-type: none"> <li>• Check that the following settings in [System Settings] are listed correctly.                             <ul style="list-style-type: none"> <li>• DNS server</li> <li>• Server name and IP address for the SMTP Server</li> </ul> <p>For details about these settings, see "Interface Settings" or "File Transfer", Settings.</p> </li> <li>• Check that the folder for transfer is correctly specified.</li> <li>• Check that the computer in which the folder for transfer is specified is correctly operated.</li> <li>• Check that the LAN cable is correctly connected to the machine.</li> <li>• For details about network problems, contact the administrator of the destinations.</li> <li>• For details about network problems, contact your administrator.</li> </ul>



Message	Cause	Solution
<p>"Check whether there are any network problems." [14-09]</p>	<p>E-mail transmission was rejected by SMTP authentication, POP before SMTP authentication, or login authentication of the computer in which the folder for transfer is specified.</p>	<ul style="list-style-type: none"> <li>• Check that user Name and password for the following settings in [System Settings] are listed correctly.                             <ul style="list-style-type: none"> <li>• SMTP Authentication</li> <li>• POP before SMTP</li> <li>• Fax Email Account</li> </ul> <p>For details about these settings, see "File Transfer", Settings.</p> </li> <li>• Check that the user ID and password for the computer with the folder for forwarding are correctly specified.</li> <li>• Check that the folder for forwarding is correctly specified.</li> <li>• Confirm that the computer with the folder for forwarding is properly working.</li> <li>• For details about network problems, contact your administrator.</li> </ul>
<p>"Check whether there are any network problems." [14-33]</p>	<p>E-mail addresses for the machine and the administrator are not registered.</p>	<ul style="list-style-type: none"> <li>• Check that the correct e-mail address is listed in [Fax Email Account] of [System Settings]. For details about fax e-mail account, see "File Transfer", Settings.</li> <li>• For details about network problems, contact your administrator.</li> </ul>

Message	Cause	Solution
<p>"Check whether there are any network problems." [15-01]</p>	<p>No POP3/IMAP4 server address is registered.</p>	<ul style="list-style-type: none"> <li>• Check that the correct Server Name or Server Address is listed in [POP3 / IMAP4 Settings] of [System Settings]. For details about POP3 / IMAP4 Settings, see "File Transfer", Settings.</li> <li>• For details about network problems, contact your administrator.</li> </ul>
<p>"Check whether there are any network problems." [15-02]</p>	<p>Cannot log in to the POP3/IMAP4 server.</p>	<ul style="list-style-type: none"> <li>• Check that the correct User Name and Password are listed in [Fax Email Account] of [System Settings]. For details about Fax Email Account, see "File Transfer", Settings.</li> <li>• For details about network problems, contact your administrator.</li> </ul>
<p>"Check whether there are any network problems." [15-03]</p>	<p>No machine e-mail address is specified.</p>	<ul style="list-style-type: none"> <li>• Check that the correct machine e-mail address is specified in [System Settings]. For details about settings of e-mail address, see "File Transfer", Settings.</li> <li>• For details about network problems, contact your administrator.</li> </ul>

Message	Cause	Solution
<p>"Check whether there are any network problems." [15-11]</p>	<p>Cannot find the DNS server or POP3/IMAP4 server.</p>	<ul style="list-style-type: none"> <li>• Check that the following settings in [System Settings] are listed correctly. <ul style="list-style-type: none"> <li>• IP address of the DNS Server</li> <li>• the server name or IP address of the POP3/IMAP4 server</li> <li>• the port number of the POP3/IMAP4 server</li> <li>• Reception Protocol</li> </ul> <p>For details about these settings, see "Interface Settings" or "File Transfer", Settings.</p> </li> <li>• Check that the LAN cable is correctly connected to the machine.</li> <li>• For details about network problems, contact your administrator.</li> </ul>
<p>"Check whether there are any network problems." [15-12]</p>	<p>Cannot log in to the POP3/IMAP4 server.</p>	<ul style="list-style-type: none"> <li>• Check that the following settings in [System Settings] are listed correctly. <ul style="list-style-type: none"> <li>• the user name and password for [Fax Email Account]</li> <li>• the user name and password for POP before SMTP authentication</li> </ul> <p>For details about these settings, see "File Transfer", Settings.</p> </li> <li>• For details about network problems, contact your administrator.</li> </ul>

Message	Cause	Solution
"Check whether there are any network problems." [16-00]	<ul style="list-style-type: none"> <li>An IP address has not been registered for the main machine.</li> <li>A network is not connected properly.</li> </ul>	<ul style="list-style-type: none"> <li>Check that the correct IP address is specified for the machine in [System Settings]. For details about the IP address of the main machine, contact your administrator.</li> <li>For details about network problems, contact your administrator.</li> </ul>

**When the remote fax function cannot be used**

Message	Cause	Solution
"Authentication with remote machine failed. Check remote machine's auth. settings."	User authentication on the main machine has failed.	For details about user authentication, see "Configuring User Authentication", Security.
"Authentication with remote machine failed. Check remote machine's auth. settings."	User Code Authentication is set on the device connected via the remote fax function.	The remote fax function does not support User Code Authentication. Disable the User Code Authentication on the main machine.
"Authentication with remote machine failed. Check remote machine's auth. settings."	The user does not have permission to use the function on the main machine.	For details about how to set permissions, see "Limiting Available Functions", Security.

Message	Cause	Solution
"Connection with the remote machine has failed. Check the remote machine status."	A network error occurred while you were using the remote fax function.	<ul style="list-style-type: none"> <li>• Check that the main machine supports the remote fax function.</li> <li>• Check that the main machine is working normally.</li> <li>• Check that the correct IP address or host name is set for the main machine in [System Settings]. For details about these settings, contact your administrator.</li> <li>• Check that the LAN cable is correctly connected to the machine.</li> <li>• For details about network problems, contact your administrator.</li> </ul>
"Connection with the remote machine has failed. Check the remote machine status."	The main machine's power is off.	Turn on the main machine's power.
"Connection with the remote machine has failed. Check the remote machine status."	A timeout error occurred while an attempt was made to connect the device via remote fax function.	<ul style="list-style-type: none"> <li>• Check that the LAN cable is correctly connected to the machine.</li> <li>• Check that the main machine is working correctly.</li> <li>• For details about connection with main machine, see "Sending/Receiving Documents Using a Remote Machine (Remote Fax)", Fax.</li> </ul>
"Connection with the remote machine has failed. There is a problem with the remote machine structure. Contact the administrator."	The settings or machine configurations for using the remote fax function to connect to the main machine are incorrect.	For details about the settings and machine configurations for using the remote fax function to connect to a main machine, contact your administrator.

Message	Cause	Solution
"Transfer error has occurred. Check the status of the remote machine."	A network error occurred during transfer.	<ul style="list-style-type: none"> <li>• Check that the correct IP address or host name is set for the main machine in [System Settings]. For details about these settings, contact your administrator.</li> <li>• Check that the main machine is working correctly.</li> <li>• Check that the LAN cable is correctly connected to the machine.</li> <li>• For details about transmission, contact your administrator.</li> </ul>
"The HDD of the remote machine is full."	The hard disk became full after using the remote fax function to scan an original.	Delete unnecessary files.

**Note**

- Settings that can be confirmed in [System Settings] or [Fax Features] on the control panel can also be confirmed by using a web browser on a networked computer. (Use Web Image Monitor, which is installed on the machine.) For details about displaying Web Image Monitor, see "Using a Web Browser", Settings. For details about using Web Image Monitor, see Web Image Monitor Help.
- If the paper tray runs out of paper, "There is no paper. Load paper." appears on the screen, prompting you to add paper. If there is paper left in the other trays, you can receive documents as usual, even if the message appears on the screen. You can turn this function on or off with "Parameter Settings". For details about how to do this, see "Parameter Settings", Fax.
- When the JPEG/PDF file that is attached to an e-mail is sent to the machine, check the message and resolve the problem accordingly. For details about messages, see page 225 "Messages Displayed on the Control Panel When You Use the Printer Function" and page 228 "Messages Printed on the Error Logs or Reports When You Use the Printer Function".
- If "Check whether there are any network problems." appears, the machine is not correctly connected to the network or the settings of the machine are not correct. If you do not need to connect to a network, you can specify the setting so this message is not displayed, and then [Check Status] no longer lights up. For details about how to do this, see "Parameter Settings", Fax. If you reconnect the machine to the network, be sure to set "Display" by configuring the appropriate user parameter.

# Messages Displayed on the Control Panel When You Use the Printer Function

This section describes the principal messages that appear on the display panel, error logs or reports. If other messages appear, follow their instructions.

## ★ Important

- Before turning off the power, see "Turning On/Off the Power", For First-time Users.

Message	Cause	Solution
"Hardware Problem: Ethernet"	An error has occurred in the Ethernet interface.	Turn off the power, and then back on again. If the message appears again, contact your service representative.
"Hardware Problem: HDD"	An error has occurred in the hard disk.	Turn off the power, and then back on again. If the message appears again, contact your service representative.
"Hardware Problem: USB"	An error has occurred in the USB interface.	Turn off the power, and then back on again. If the message appears again, contact your service representative.
"Hardware Problem: Wireless Card" (A "wireless LAN board" is referred to as a "wireless card".)	<ul style="list-style-type: none"> <li>• The wireless LAN board has malfunctioned.</li> <li>• The wireless LAN board you are using is not compatible with this machine.</li> </ul>	Turn off the power, and then confirm the wireless LAN board is inserted correctly. And then, turn on the power again. If the message appears again, contact your service representative.
"Load following paper in n. To force print, select another tray and press [Continue]." (("n" is replaced by a variable.)	The printer driver settings are incorrect or the tray does not contain paper of the size selected in the printer driver.	Check that the printer driver settings are correct, and then load paper of the size selected in the printer driver into the input tray. For details about how to change the paper size, see "Changing the Paper Size", For First-time Users.

Message	Cause	Solution
<p>"Paper size and type are mismatched. Select another tray from the following and press [Continue]. To cancel job, press [Job Reset]. Paper size and type can also be changed in User Tools."</p>	<p>The printer driver settings are incorrect or the tray does not contain paper of the size or type selected in the printer driver.</p>	<ul style="list-style-type: none"> <li>• Check that the printer driver settings are correct, and then load paper of the size selected in the printer driver into the input tray. For details about how to change the paper size, see "Changing the Paper Size", For First-time Users.</li> <li>• Select the tray manually to continue printing, or cancel a print job. For details about how to select the tray manually, or cancel a print job, see "If an Error Occurs with the Specified Paper Size and Type", Print.</li> </ul>
<p>"Paper type of n is mismatched. Select another tray from the following and press [Continue]. Paper type can also be changed in User Tools." (A tray name is placed at n.)</p>	<p>The type of the paper in the tray does not match the paper type specified in the printer driver.</p>	<p>Select a tray containing paper that is the same type as the specified paper type.</p>
<p>"Parallel I/F board has a problem."</p>	<p>An error has occurred in the IEEE 1284 interface board.</p>	<p>Turn off the power, and then back on again. If the message appears again, contact your service representative.</p>
<p>"Printer font error."</p>	<p>An error has occurred in the font settings.</p>	<p>Contact your service representative.</p>



**When using direct print from a memory storage device**

Message	Cause	Solution
"Exceeded the limit value for total data size of the selected files. Cannot select more files."	<ul style="list-style-type: none"> <li>• The size of the selected file exceeds 1 GB.</li> <li>• The total size of the selected files exceeds 1 GB.</li> </ul>	<p>Files or groups of files larger than 1 GB cannot be printed.</p> <ul style="list-style-type: none"> <li>• When the total size of the multiple files that are selected exceeds 1 GB, select files separately.</li> <li>• When the size of the selected file exceeds 1 GB, print from a memory storage device using a function other than the Direct printing function.</li> </ul> <p>You cannot select files of different formats at the same time.</p>
"Unable to access the specified memory storage device."	<ul style="list-style-type: none"> <li>• An error occurred when the machine accessed the memory storage device or a file stored on the memory storage device.</li> <li>• An error occurred when the user used the Direct printing function to print from a memory storage device.</li> </ul>	<p>Save the file to a different memory storage device, and then print again.</p>

# Messages Printed on the Error Logs or Reports When You Use the Printer Function

This section describes likely causes of and possible solutions for the error messages that are printed on the error logs or reports.

## When print jobs are canceled

Message	Cause	Solution
"91: Error"	Printing was canceled by the auto job cancel function due to a command error.	Check that the data is valid.
"Error occurred, not printed job via network exists. It is stored as job not printed."	Jobs with errors were stored because an error occurred with a print job via the network while the error job storing function was enabled.	Contact your administrator to check whether the machine is connected correctly to the network. For details about how to check and print jobs stored when print configuration errors occur, see "Printing of Documents Stored When Print Configuration Errors Occur", Print.
"Error occurred while processing an Unauthorized Copy Prevention job. Job cancelled."	You tried to store a file in the Document Server when the [Unauthorized Copy Prevention] was specified.	On the printer driver, select a job type other than [Document Server] in "Job Type:" or deselect [Unauthorized Copy Prevention].
"Error occurred while processing an Unauthorized Copy Prevention job. Job cancelled."	The [Enter User Text:] field on the [Unauthorized Copy Prevention for Pattern Details] screen is blank.	On the printer driver's [Detailed Settings] tab, click [Effects] in "Menu:". Select [Unauthorized Copy Prevention], and then click [Details...] to display [Unauthorized Copy Prevention for Pattern Details]. Enter text in [Enter User Text:].
"Error occurred while processing an Unauthorized Copy Prevention job. Job cancelled."	The resolution is set to a value less than 600 dpi when [Unauthorized Copy Prevention] is specified.	On the printer driver, set the resolution to 600 dpi or higher, or cancel [Unauthorized Copy Prevention].

Message	Cause	Solution
"Error occurred while processing an Unauthorized Copy Prevention job. Job cancelled."	In [Administrator Tools] under [System Settings], priority was specified to be given to Unauthorized Copy Prevention Printing set on this machine.	Cancel Unauthorized Copy Prevention Printing for the printer driver. For details about how to cancel the settings, see the printer driver Help.
"Collate Cancelled"	Collate was canceled.	Turn off the power, and then back on again. If the message appears again, contact your service representative.
"You reach the usage limit. This job has been cancelled."	The number of pages the user is permitted to print has been exceeded.	For details about print volume use limitation, see "Managing Print Volume per User", Security.
"Receiving data failed."	Data reception was aborted.	Resend the data.
"Sending data failed."	The machine received a command to stop transmission from the printer driver.	Check if the computer is working correctly.
"The selected paper size is not supported. This job has been cancelled."	Job reset is automatically performed if the specified paper size is incorrect.	Specify the correct paper size, and then print the file again.
"The selected paper type is not supported. This job has been cancelled."	Job reset is automatically performed if the specified paper type is incorrect.	Specify the correct paper type, and then print the file again.

**When there is a problem with the print settings**

Message	Cause	Solution
"Classification Code is incorrect."	The classification code has not been entered, or the classification code has been entered incorrectly.	Enter the correct classification code.
"Classification Code is incorrect."	The classification code is not supported with the printer driver.	Select [Optional] for classification code. For details about how to specify classification code settings, see "Configuring Classification Codes", Print.

Message	Cause	Solution
"Duplex Cancelled"	Duplex printing was canceled.	Change the setting for "Apply Duplex" in [Tray Paper Settings] to enable duplex printing for the paper tray. For details about setting "Apply Duplex", see "Tray Paper Settings", Settings.
"Exceeded Max. Pages (Collate)"	The number of pages exceeds the maximum number of sheets that you can use Collate with.	Reduce the number of pages to print.
"Output Tray Changed"	The output tray was changed because the paper size of the specified output tray is limited.	Specify the proper output tray.
"Print Overrun"	Images were discarded while printing.	Select a lower resolution on the printer driver. For details about how to change the resolution setting, see the printer driver Help.

**When documents cannot be stored in the Document Server**

Message	Cause	Solution
"Cannot store data of this size."	The paper size exceeded the capacity of the Document Server.	Reduce the paper size of the file that you want to send to a size that the Document Server can store. Custom size files can be sent but not stored afterward.
"Document Server is not available to use. Cannot store."	You cannot use the Document Server function.	For details about using Document Server function, contact your administrator.  For details about how to set permissions, see "Limiting Available Functions", Security.
"Exceeded max capacity of document server. Cannot store."	The hard disk became full after a file was stored.	Delete some of the files stored in the Document Server or reduce the size that you want to send.

Message	Cause	Solution
"Exceeded max number of files of document server. Cannot store."	The maximum file capacity of the Document Server was exceeded.	Delete some of the files stored in the Document Server.
"Exceeded max. number of files. (Auto)"	While you were using the error job store function to store Normal Print jobs as Hold Print files, the maximum file capacity for file storage or Hold Print file management (automatic) was exceeded.	Delete Hold Print files (automatic) or unneeded files stored on the machine.
"Exceeded max number of pages of document server. Cannot store."	The maximum page capacity of the Document Server was exceeded.	Delete some of the files stored in the Document Server or reduce the number of pages that you want to send.
"Exceeded max. number of pages. (Auto)"	While you were using the error job store function to store Normal Print jobs as Hold Print files, the maximum page capacity was exceeded.	Delete unneeded files stored on the machine. Reduce the number of pages to print.
"Job cancelled because capture file could not be stored: Exceeded max. memory."	The hard disk became full after a file was stored.	Delete the files stored in the Document Server or reduce the file size to be sent.
"Job cancelled because capture file could not be stored: Exceeded max. files."	The maximum file capacity of the Document Server was exceeded.	Delete the files stored in the Document Server.
"Job cancelled because capture file could not be stored: Exceeded max pages per file."	The maximum page capacity of the Document Server was exceeded.	Delete some of the files stored in the Document Server or reduce the number of pages that you want to send.
"The specified folder in Document Server is locked. Cannot store."	The specified folder is locked.	Unlock the folder or specify another folder number that can be used. For details about locked folders, see "Managing Folders", Security.

**When there is not enough free hard disk space**

Message	Cause	Solution
"HDD Full"	When you were printing with the PostScript 3 printer driver, the hard disk capacity for fonts and forms was exceeded.	Delete unneeded forms or fonts registered on the machine.
"HDD Full"	The hard disk became full while you were printing a Sample Print, Locked Print, Hold Print, or Stored Print file.	Delete unneeded files stored on the machine. Alternatively, reduce the data size of the Sample Print, Locked Print, Hold Print, or Stored Print file.
"HDD is full. (Auto)"	The hard disk became full while you were using the error job store function to store Normal Print jobs as Hold Print files.	Delete unneeded files stored on the machine. Alternatively, reduce the data size of the Temporary Print file and/or the Stored Print file.

**When there is not enough memory**

Message	Cause	Solution
"84: Error"	There is no work area available for image processing.	Decrease the number of files sent to the machine.

**When there is a problem with a parameter**

Message	Cause	Solution
"86: Error"	Parameters of the control code are invalid.	Check the print settings.

**When the user lacks privileges to perform an operation**

Message	Cause	Solution
"No response from the server. Authentication has failed."	A timeout occurred while connection to the server was being established for LDAP authentication or Windows Authentication.	Check the status of the server.

Message	Cause	Solution
"You do not have a privilege to print this PDF file."	You have no privileges to print the PDF document you tried to print.	Contact the owner of the document.
"You do not have a privilege to use this function. This job has been cancelled."	The entered login user name or login password is not correct.	Check that the user name and password are correct.
"You do not have a privilege to use this function. This job has been cancelled."	The logged in user is not allowed to use the selected function.	For details about how to set permissions, see "Configuring User Authentication", Security.
"You do not have a privilege to use this function. This operation has been cancelled."	The logged in user does not have the privileges to register programs or change the paper tray settings.	For details about how to set permissions, see "Configuring User Authentication", Security.

#### When a user cannot be registered

Message	Cause	Solution
"Auto-registration of user information has failed."	Automatic registration of information for LDAP Authentication or Windows Authentication failed because the Address Book is full.	For details about automatic registration of user information, see "Auto Registration to the Address Book", Security.
"Information for user authentication is already registered for another user."	The user name for LDAP was already registered in a different server with a different ID, and a duplication of the user name occurred due to a switching of domains (servers), etc..	For details about user authentication, see "Configuring User Authentication", Security.

#### When other errors occur

Message	Cause	Solution
"85: Error"	The specified graphics library is unavailable.	Check that the data is valid.

Message	Cause	Solution
"98: Error"	The machine could not access the hard disk correctly.	Turn off the power, and then back on again. If the message appears frequently, contact your service representative.
"99: Error"	This data cannot be printed. The specified data is either corrupt or it cannot be printed from a memory storage device using the Direct printing function.	Check that the data is valid. For details about the kinds of data that can be printed from a memory storage device using the Direct printing function, see "Direct Printing from a Memory Storage Device", Print.
"Command Error"	An RPCS command error occurred.	Check using the following procedure: <ul style="list-style-type: none"> <li>• Check if the communication between the computer and the machine is working correctly.</li> <li>• Check if the correct printer driver is being used.</li> <li>• Check if the machine's memory size is set correctly in the printer driver.</li> <li>• Check that the printer driver is the most up-to-date version available.</li> </ul>
"Compressed Data Error"	The machine detected corrupt compressed data.	<ul style="list-style-type: none"> <li>• Check the connection between the computer and the machine.</li> <li>• Check that the program you used to compress the data is functioning correctly.</li> </ul>
"Data Storage Error"	You tried to print a Sample Print, Locked Print, Hold Print, or Stored Print file, or to store a file in the Document Server when the hard disk was malfunctioning.	Contact your service representative.
"PDF file error. Cannot print."	A syntax error, etc., occurred.	Check that the PDF file is valid.



Message	Cause	Solution
"Exceeded Max. Stored Files"	While printing a Sample Print, Locked Print, Hold Print, or Stored Print file, the maximum file capacity was exceeded.	Delete unneeded files stored on the machine.
"Exceeded Max. Stored Pages"	While printing a Sample Print, Locked Print, Hold Print, or Stored Print file, the maximum page capacity was exceeded.	Delete unneeded files stored on the machine. Reduce the number of pages to print.
"File system error. Cannot print PDF file(s)."	PDF direct printing could not be performed because the file system could not be obtained.	Turn off the power, and then back on again. If the message appears again, contact your service representative.
"Exceeded max. capacity of system file. Cannot print PDF file(s)."	PDF file does not print out because the capacity of the file system is full.	Delete all unnecessary files from the hard disk, or decrease the file size sent to the machine.
"I/O Buffer Overflow"	An input buffer overflow occurred.	<ul style="list-style-type: none"> <li>In [Printer Features], under [Host Interface], select [I/O Buffer], and then set the maximum buffer size to a larger value.</li> <li>Reduce the number of files being sent to the machine.</li> </ul>
"Insufficient Memory"	A memory allocation error occurred.	<b>PCL 6</b> On the printer driver's [Detailed Settings] tab, click [Print Quality:Advanced] in "Menu:", and then select [Raster] in the "Vector/Raster:" list. In some cases, it will take a long time to complete a print job.
"Memory Retrieval Error"	A memory allocation error occurred.	Turn off the power and then back on again. If the message appears again, replace the RAM. For details about replacing the RAM, contact your service representative.

If printing does not start, contact your service representative.

 **Note**

- The contents of errors may be printed on the Configuration Page. Check the Configuration Page in conjunction with the error log. For details about how to print the Configuration Page, see "List / Test Print", Print.

# Messages Displayed on the Control Panel When You Use the Scanner Function

This section describes likely causes of and possible solutions for the error messages that appear on the control panel. If a message not described here appears, act according to the message.

Message	Cause	Solution
"Cannot find the specified path. Please check the settings."	The destination computer name or folder name is invalid.	Check whether the computer name and the folder name for the destination are correct.
"Cannot find the specified path. Please check the settings."	An antivirus program or a firewall is preventing the machine from connecting to your computer.	<ul style="list-style-type: none"> <li>• Antivirus programs and firewalls can prevent client computers from establishing connection with this machine.</li> <li>• If you are using antivirus software, add the program to the exclusion list in the application settings. For details about how to add programs to the exclusion list, see the antivirus software Help.</li> <li>• To prevent a firewall from blocking the connection, register the machine's IP address in the firewall's IP address exclusion settings. For details about the procedure for excluding an IP address, see your operating system's Help.</li> </ul>
"Entered user code is not correct. Please re-enter."	You have entered an incorrect user code.	Check the authentication settings, and then enter a correct user code.
"Exceeded max. number of alphanumeric characters for the path."	The maximum number of specifiable alphanumeric characters in a path has been exceeded.	Check the maximum number of characters which can be entered, and then enter it again. For details about the maximum enterable number of characters, see "Values of Various Set Items for Transmission/Storage Function", Scan.

Message	Cause	Solution
"Exceeded max. number of alphanumeric characters."	The maximum enterable number of alphanumeric characters has been exceeded.	Check the maximum number of characters which can be entered, and then enter it again. For details about the maximum enterable number of characters, see "Values of Various Set Items for Transmission/Storage Function", Scan.
"Exceeded the maximum number of OCR jobs that can be on standby for storing, please wait. Try again after storing of the current job has completed."	The maximum allowable number of jobs on standby was exceeded because large quantities of documents were stored by the OCR function.	Up to 100 jobs can be placed on standby by the OCR function. Scan the next document after the current jobs have finished being stored.
"File types have been automatically set for some files because multiple files were selected."	If there are selected stored documents which cannot be converted to a specified file format, those documents are automatically converted to a convertible format before they are transmitted.	For details about the file formats used to transmit stored documents, see "Sending a Stored File", Scan.
"Programmed. Cannot program the destination(s) that is not programmed in the address book."	The destinations that were selected while registered to the program contain a folder destination for which one of the following destinations is set:  manually entered destination, WSD destination, or DSM destination	WSD destinations and DSM destinations cannot be registered to the program because they cannot be registered in the address book. For manually entered destinations, register the destinations in the address book, and then try to register them to the program again.
"Scanner journal is full. Please check Scanner Features."	"Print & Delete Scanner Journal" in [Scanner Features] is set to [Do not Print: Disable Send], and Scanner Journal is full.	Print or delete Scanner Journal. For details about Scanner Features, see "General Settings", Scan.

Message	Cause	Solution
<p>"The entered file name contains invalid character(s). Enter the file name again using any of the following 1 byte characters. "0 to 9", "A to Z", "a to z", ". - _"</p>	<p>The file name contains a character that cannot be used.</p>	<ul style="list-style-type: none"> <li>• Check the file name set at the time of scanning. For details about characters that can be used in file names, see "Specifying the File Name", Scan.</li> <li>• Check the file name specified at the time of scanning. The file name specified in the Sending Scan Files to Folders function cannot contain the following characters:  <code> \ / : * ? " &lt; &gt;  </code>                      The file name cannot start or end with a period ".".</li> </ul>
<p>"The program is recalled. Cannot recall the destination(s) for which access privileges are required."</p>	<p>The currently logged-in user does not have permission to view the destination that was registered in the program.</p>	<p>For details about how to set permissions, see "Limiting Available Functions", Security.</p>
<p>"The program is recalled. Cannot recall the destination(s) that is deleted from the address book."</p>	<p>The destination stored in the program could not be recalled because it was deleted from the address book.</p>	<p>Enter the destination directly to send data separately.</p>
<p>"The program is recalled. Cannot recall the folder destination(s) with protection code(s)."</p>	<p>The folder destinations for which the protection code was set were registered in the program.</p>	<p>A destination for which the protection code is set cannot be recalled by the program. Cancel the protection code setting or send scanned files to the destination separately.</p>

**When documents cannot be scanned properly**

Message	Cause	Solution
"All the pages are detected as blank. No file was created."	No PDF file was created because all the pages of the scanned original were detected as blank when [On] is specified for [Delete Blank Page] in [OCR Settings].	Check whether the original is set upside down.  Change [OCR Scanned PDF: Blank Page Sensitivity] in [Scanner Features] to "Sensitivity Level 1".
"Check original's orientation."	Originals may sometimes not be scanned depending on a combination of items such as the specified scaling factor and document size.	Change the orientation of the original, and then scan the original again.
"Exceeded max. data capacity."  "Check scanning resolution, then press Start key again."	The scanned data exceeded maximum data capacity.	Specify the scan size and resolution again. Note that it may not be possible to scan very large originals at a high resolution. For details about the settings for the scanner function, see "Relationship between Resolution and Scan Size", Scan.
"Exceeded max. data capacity."  "Check the scanning resolution, then reset n original(s)."  ("n" in the message represents a variable.)	The scanned original exceeded maximum data capacity.	Specify the scan size and resolution again. Note that it may not be possible to scan very large originals at a high resolution. For details about the settings for the scanner function, see "Relationship between Resolution and Scan Size", Scan.
"Exceeded max. data capacity."  "Check the resolution and the ratio and then press the Start key again."	The data being scanned is too large for the scale ratio specified in [Specify Size].	Reduce the resolution or [Specify Size] value, and then scan the original again.

Message	Cause	Solution
"Exceeded max. number of files which can be used in Document Server at the same time."	The maximum number of files that can be stored in the Document Server has been exceeded.	Check the files stored by the other functions, and then delete unneeded files. For details about how to delete files, see "Deleting Stored Documents", Copy/Document Server.
"Not all of the image will be scanned." "Check the ratio and then press the Start key again."	If the scaling factor specified in "Specify Reproduction Ratio" is too large, part of the image may be lost.	Reduce the scaling factor in "Specify Reproduction Ratio", and then try to scan the original again.  If displaying the entire image is not necessary, press [Start] to start scanning with the current scaling factor.
"Not all of the image will be scanned." "Check the ratio and then press the Start key again."	Using "Specify Reproduction Ratio" to scale down a large document may cause part of the image to be lost.	Specify a large size in [Specify Size], and then scan the original again.  If displaying the entire image is not necessary, press [Start] to start scanning with the current scaling factor.
"The size of the scanned data is too small." "Check the resolution and the ratio and then press the Start key again."	The data being scanned is too small for the scale ratio specified in [Specify Size].	Specify a higher resolution or a large size in [Specify Size], and then scan the original again.

**When documents cannot be scanned because the memory is full**

Message	Cause	Solution
"Memory is full. Cannot scan. The scanned data will be deleted."	Because of insufficient hard disk space, the first page could not be scanned.	Try one of the following measures: <ul style="list-style-type: none"> <li>• Wait for a while, and then retry the scan operation.</li> <li>• Reduce the scan area or scanning resolution. For details about changing scan area and scanning resolution, see "Scan Settings" of Various Scan Settings, Scan.</li> <li>• Delete unneeded stored files. For details about how to delete stored files, see "Deleting a Stored File", Scan.</li> </ul>
"Memory is full. Do you want to store scanned file?"	Because there is not enough free hard disk space in the machine for storing in the Document Server, only some of the pages could be scanned.	Specify whether or not to use the data.
"Memory is full. Scanning has been cancelled. Press [Send] to send the scanned data, or press [Cancel] to delete."	Because there is not enough free hard disk space in the machine for sending by e-mail while data is being stored in the Document Server, only some of the pages could be scanned.	Specify whether or not to use the data.

**When data transmission fails**

Message	Cause	Solution
"Authentication with the destination has failed. Check settings. To check the current status, press [Scanned Files Status]."	The entered user name or password was invalid.	<ul style="list-style-type: none"> <li>• Check that the user name and password are correct.</li> <li>• Check that the ID and password for the destination folder are correct.</li> <li>• A password of 128 or more characters may not be recognized.</li> </ul>



Message	Cause	Solution
"Connection with PC has failed. Check the settings."	The destination computer name or folder name is invalid.	Check whether the computer name and the folder name for the destination are correct.
"Exceeded max. email size. Sending email has been cancelled. Check [Max. Email Size] in Scanner Features."	The file size per page has reached the maximum e-mail size specified in [Scanner Features].	Change the scanner features settings as follows: <ul style="list-style-type: none"> <li>• Increase the e-mail size limit in [Max. Email Size].</li> <li>• Change the [Divide &amp; Send Email] setting to [Yes (per Page)] or [Yes (per Max. Size)]. For details about these settings, see "Send Settings", Scan.</li> </ul>
"Sending the data has failed. The data will be resent later."	A network error has occurred and a file was not sent correctly.	Wait until sending is retried automatically after the preset interval. If sending fails again, contact your administrator.
"Transmission has failed. Insufficient memory in the destination hard disk. To check the current status, press [Scanned Files Status]."	Transmission has failed. There was not enough free space on the hard disk of the SMTP server, FTP server, or client computer at the destination.	Allocate sufficient space.
"Transmission has failed. To check the current status, press [Scanned Files Status]."	While a file was being sent, a network error occurred and the file could not be sent correctly.	If the same message appears again after scanning again, the cause could be a mixed network, or network settings were changed during WSD scanner transmission. For details about network error, contact your administrator.

**When data cannot be sent because a currently used file is selected**

Message	Cause	Solution
"Selected file is currently in use. File name cannot be changed."	You cannot change the name of a file whose status is "Waiting...".	Cancel transmission ("Waiting..." status cleared), and then change the file name.

Message	Cause	Solution
"Selected file is currently in use. Password cannot be changed."	You cannot change the password of a file whose status is "Waiting...".	Cancel transmission ("Waiting..." status cleared), and then change the password.
"Selected file is currently in use. User name cannot be changed."	You cannot change the sender's name whose status is "Waiting...".	Cancel transmission ("Waiting..." status cleared), and then change the user name.
"Some of selected files are currently in use. They could not be deleted."	You cannot delete a file which is waiting to be transmitted ("Waiting..." status displayed).	Cancel transmission ("Waiting..." status cleared), and then delete the file.

**When data cannot be sent because there are too many documents or pages**

Message	Cause	Solution
"Exceeded max. number of pages per file. Do you want to store the scanned pages as 1 file?"	The file being stored has exceeded the maximum number of pages for one file.	Specify whether to store the data or not. Scan the pages that were not scanned, and then store them as a new file. For details about storing files, see "Storing and Saving the Scanned Documents", Scan.
"Exceeded max. number of stored files. Cannot send the scanned data as capturing files is unavailable."	Too many files are waiting to be sent.	Try again after they have been sent.
"Exceeded max. page capacity per file. Press [Send] to send the scanned data, or press [Cancel] to delete."	The number of scanned pages exceeded the maximum page capacity.	Specify whether to send the data that has already been scanned.
"Exceeded maximum number of file to store. Delete all unnecessary files."	Too many files are waiting to be sent.	Try again after they have been sent.

**When the WSD scanner function cannot be used**

Message	Cause	Solution
"Cannot communicate with PC. Contact the administrator."	WSD (Device) protocol or WSD (Scanner) protocol is disabled.	For details about how to enable or disable the WSD protocol, see "Enabling and Disabling Protocols", Security.
"Cannot start scanning because communication was failed."	Scan Profile is not set on the client computer.	Set Scan Profile. For details about how to do this, see "Creating a New Scan Profile", Scan.
"Cannot start scanning because communication was failed."	The [Take no action] setting has been selected on the client computer, forcing the client computer to remain inactive when it receives scan data.	Open scanner properties, click the [Events] tab, and then select [Start this program] as the computer's response when it receives scan data. For details, see your operating system's Help.
"Cannot start scanning. Check the setting(s) on the PC."	The Scan Profile might be incorrectly configured.	Check the Scan Profile configuration.
"Could not send the data because the PC timed out before it was sent."	<p>A time out occurred when WSD Scanner was used. Time outs occur when too much time passes between scanning an original and sending its data. The followings are likely causes of time outs:</p> <ul style="list-style-type: none"> <li>• Too many originals per set.</li> <li>• Misfed originals.</li> <li>• Transmission of other jobs.</li> </ul>	<ul style="list-style-type: none"> <li>• Reduce the number of originals, and then scan again.</li> <li>• Remove any misfed original, and then scan again.</li> <li>• Use Scanner Journal to check there are no jobs awaiting transmission, and then scan again.</li> </ul>

**When documents cannot be stored on a memory storage device**

Message	Cause	Solution
"Cannot write on the memory storage device because remaining free space is insufficient."	The memory storage device is full and scan data cannot be saved. Even if the memory storage device appears to have sufficient free space, data might not be saved if the maximum number of files that can be saved is exceeded.	<ul style="list-style-type: none"> <li>• Replace the memory storage device.</li> <li>• If the document is scanned as single-page or divided into multiple pages, data already written to the memory storage device is saved as is. Replace the memory storage device, and then press [Retry] to save the remaining data, or press [Cancel] to redo the scan.</li> </ul>
"Cannot write on the memory storage device because the device is write-protected."	The memory storage device is write-protected.	Unlock the write-protection on the memory storage device.
"Cannot write on the memory storage device. Check the memory storage device and machine settings."	The memory storage device is faulty, or the file name contains a character that cannot be used.	<ul style="list-style-type: none"> <li>• Check to see if the memory storage device is defective.</li> <li>• Check the memory storage device. It might be unformatted, or its format might be incompatible with this machine.</li> <li>• Check the file name set at the time of scanning. For details about the characters that can be used in file names, see "Specifying the File Name", Scan.</li> </ul>
"Exceeded max. page capacity per file. Press [Write] to write the scanned data to the memory storage device, or press [Cancel] to delete."	The scan could not be completed because the maximum number of pages that can be scanned by this machine was exceeded during the scanned data was written to the memory storage device.	Reduce the number of documents to be written to the memory storage device, and then try again.

Message	Cause	Solution
<p>"Memory is full. Press [Write] to write the current scanned data to the memory storage device, or press [Cancel] to delete."</p>	<p>The scan could not be completed because there was insufficient hard disk memory when the scanned data was saved to the memory storage device.</p>	<p>Specify whether or not to save the scanned document to the memory storage device.</p>

## Messages Displayed on the Client Computer When You Use the Scanner Function

This section describes likely causes of and possible solutions for the main error messages displayed on the client computer when you use the TWAIN driver. If a message not described here appears, follow the instruction.

Message	Cause	Solution
"Any of Login User Name, Login Password or Driver Encryption Key is incorrect."	The entered login user name, password, or driver encryption key was invalid.	Check your login user name, login password, or driver encryption key, and then enter them correctly. For details about login user name, login password, and driver encryption key, see "Encrypting Transmitted Passwords", Security.
"Authentication succeeded. However, the access privileges for scanner function has been denied."	The logged in user name does not have permissions for scanner function.	For details about how to set permissions, see "Limiting Available Functions", Security.
"Cannot add any more scanning mode."	The maximum number of registrable scan modes has been exceeded.	The maximum number of modes that can be stored is 100. Delete unneeded modes.
"Cannot detect the paper size of the original. Specify the scanning size."	The set original was misaligned.	<ul style="list-style-type: none"> <li>Place the original correctly.</li> <li>Specify the scan size.</li> <li>When placing an original directly on the exposure glass, the lifting/lowering action of the exposure glass cover or the Auto Document Feeder (ADF) triggers the automatic original size detection process. Lift the exposure glass cover or the ADF 30 degrees or more.</li> </ul>
"Cannot specify any more scanning area."	The maximum number of registrable scan modes has been exceeded.	The maximum number of scanning areas that can be stored is 100. Delete unneeded scanning areas.

Message	Cause	Solution
"Clear Misfeed(s) in ADF."	A paper misfeed has occurred inside the ADF.	<ul style="list-style-type: none"> <li>Remove the jammed originals, and then insert them again. For details about jammed paper, see "Removing Jammed Paper", Troubleshooting.</li> <li>When a misfeed occurs, replace the jammed originals.</li> <li>Check whether the originals are suitable to be scanned by the machine.</li> </ul>
"Error has occurred in the scanner driver."	An error has occurred in the driver.	<ul style="list-style-type: none"> <li>Check whether the network cable is connected correctly to the client computer.</li> <li>Check whether the Ethernet board of the client computer is recognized correctly by Windows.</li> <li>Check whether the client computer can use the TCP/IP protocol.</li> </ul>
"Error has occurred in the scanner."	The application-specified scan conditions have exceeded the setting range of the machine.	Check whether the scanning settings made with the application exceed the setting range of the machine.
"Fatal error has occurred in the scanner."	An unrecoverable machine error has occurred.	An unrecoverable machine error has occurred. Contact your service representative.
"Insufficient memory. Close all other applications, then restart scanning."	Memory is insufficient.	<ul style="list-style-type: none"> <li>Close all the unnecessary applications running on the client computer.</li> <li>Uninstall the TWAIN driver, and then reinstall it after restarting the computer.</li> </ul>

Message	Cause	Solution
<p>"Insufficient memory. Reduce the scanning area."</p>	<p>Scanner memory is insufficient.</p>	<ul style="list-style-type: none"> <li>• Reset the scan size.</li> <li>• Lower the resolution.</li> <li>• Set with no compression. For details about the settings, see TWAIN driver Help.</li> </ul> <p>The problem may be due to the following:</p> <ul style="list-style-type: none"> <li>• Scanning cannot be performed if large values are set for brightness when halftone or high resolution is used. For details about the relationship between scan settings, see "Relationship between Resolution and Scan Size", Scan.</li> <li>• If a misfeed occurs, you might not scan an original. Remove the misfeed, and then scan the original again.</li> </ul>
<p>"Invalid Winsock version. Please use version 1.1 or higher."</p>	<p>You are using an invalid version of Winsock.</p>	<p>Install the operating system of the computer or copy Winsock from the operating system CD-ROM.</p>
<p>"No response from the scanner."</p>	<p>The machine or client computer is not connected to the network correctly.</p>	<ul style="list-style-type: none"> <li>• Check whether the machine or client computer is connected to the network correctly.</li> <li>• Disable the client computer's own firewall. For details about firewall, see Windows Help.</li> </ul>
<p>"No response from the scanner."</p>	<p>The network is crowded.</p>	<p>Wait for a while, and then connect to the network again.</p>



Message	Cause	Solution
"Scanner is in use for other function. Please wait."	A function of the machine other than the scanner function is being used such as the copier function.	<ul style="list-style-type: none"> <li>• Wait for a while, and then connect to the network again.</li> <li>• Cancel the job that is being processed. Press [Stop]. Follow the instructions in the message that appears and exit the function that is running.</li> </ul>
"Scanner is not available on the specified device."	The TWAIN scanner function cannot be used on this machine.	Contact your service representative.
"Scanner is not ready. Check the scanner and the options."	The ADF cover is open.	Check whether the ADF cover is closed.
"The name is already in use. Check the registered names."	You tried to register a name that is already in use.	Use another name.

**When there is a problem connecting to the scanner**

Message	Cause	Solution
"Cannot connect to the scanner. Check the network Access Mask settings in User Tools."	An access mask is set.	For details about an access mask, contact your administrator.
"Cannot find "XXX" scanner used for the previous scan. "YYY" will be used instead." ("XXX" and "YYY" indicate scanner names.)	The main power of the previously used scanner is not set to "On".	Check whether the main power of the scanner used for the previous scan is turned on.

Message	Cause	Solution
<p>"Cannot find "XXX" scanner used for the previous scan. "YYY" will be used instead." ("XXX" and "YYY" indicate scanner names.)</p>	<p>The machine is not connected to the network correctly.</p>	<ul style="list-style-type: none"> <li>• Check that the previously used scanner is connected to the network correctly.</li> <li>• Cancel the personal firewall of the client computer. For details about firewall, see Windows Help.</li> <li>• Use an application such as telnet to make sure SNMPv1 or SNMPv2 is set as the machine's protocol. For details about how to check this, see "Remote Maintenance Using telnet", Settings.</li> <li>• Select the scanner used for the previous scan.</li> </ul>
<p>"Communication error has occurred on the network."</p>	<p>A communication error has occurred on the network.</p>	<p>Check whether the client computer can use the TCP/IP protocol.</p>
<p>"Scanner is not available. Check the scanner connection status."</p>	<p>The machine's power is off.</p>	<p>Turn on the power.</p>
<p>"Scanner is not available. Check the scanner connection status."</p>	<p>The machine is not connected to the network correctly.</p>	<ul style="list-style-type: none"> <li>• Check whether the machine is connected to the network correctly.</li> <li>• Cancel the personal firewall function of the client computer. For details about firewall, see Windows Help.</li> <li>• Use an application such as telnet to make sure SNMPv1 or SNMPv2 is set as the machine's protocol. For details about how to check this, see "Remote Maintenance Using telnet", Settings.</li> </ul>

Message	Cause	Solution
<p>"Scanner is not available. Check the scanner connection status."</p>	<p>Network communication is not available because the machine's IP address could not be obtained from the host name. If only "IPv6" is set to [Active], the IPv6 address might not be obtained.</p>	<ul style="list-style-type: none"> <li>• Check whether the machine's host name is specified in the Network Connection Tool. For the WIA driver, check the [Network Connection] tab in the properties.</li> <li>• Use Web Image Monitor to set "LLMNR" of "IPv6" to [Active]. (Web Image Monitor is a management tool installed on this machine to monitor this machine or configure settings for this machine by using a web browser.)</li> </ul>

## When Other Messages Appear

### When there is a problem scanning or storing originals

Message	Cause	Solution
"Cannot detect original size. Select scan size."	The machine failed to detect the size of the original.	<ul style="list-style-type: none"> <li>Place the original correctly.</li> <li>Specify the scan size, and then place the originals again. For details about the settings for when fax function is being used, see "Specifying Scan Settings for Originals for Fax Transmission", Fax.</li> <li>Specify the scan size, and then place the originals again.</li> <li>When placing an original directly on the exposure glass, the lifting/lowering action of the exposure glass cover or the Auto Document Feeder (ADF) triggers the automatic original size detection process. Lift the exposure glass cover or the ADF 30 degrees or more.</li> </ul>
"Captured file exceeded max. number of pages per file. Cannot send the scanned data."	The maximum number of pages per file has been exceeded.	Reduce the number of pages in the transmitted file, and then resend the file. For details about the maximum number of pages per file, see "Basic Procedure for Storing Scan Files", Scan.
"Original is being scanned by another function. Please wait."	Another function of the machine is being used.	Cancel the job in progress. Press [Exit], and then press [Stop]. Follow the instructions in the message that appears and exit the function that is running.

**When the address book is updated**

Message	Cause	Solution
"Updating the destination list has failed. Try again?"	A network error has occurred.	<ul style="list-style-type: none"> <li>• Check whether the server is connected.</li> <li>• Antivirus programs and firewalls can prevent client computers from establishing connection with this machine.</li> <li>• If you are using antivirus software, add the program to the exclusion list in the application settings. For details about how to add programs to the exclusion list, see the antivirus software Help.</li> <li>• To prevent a firewall from blocking the connection, register the machine's IP address in the firewall's IP address exclusion settings. For details about the procedure for excluding an IP address, see your operating system's Help.</li> </ul>
"Updating the destination list... Please wait. Specified destination(s) or sender's name has been cleared."	The destination list is being updated by using a web browser on a networked computer.	Wait until the message disappears. Do not turn off the power while this message is displayed. Depending on the number of destinations to be updated, there may be some delay before operation is resumed. Operation is not possible while this message is displayed.
"Updating the destination list... Please wait. Specified destination(s) or sender's name has been cleared."	A specified destination or sender's name was cleared when the destination list in the delivery server was updated.	Specify the destination or sender's name again.

**When data cannot be sent due to a problem with the destination**

Message	Cause	Solution
"Some invalid destination(s) contained. Do you want to select only valid destination(s)?"	The specified group contains either an e-mail destination and/or folder destination that is not supported by the specified transmission method.	In the message that appears at each transmission, press [Select].
"SMTP authentication email address and administrator email address mismatch."	The SMTP authentication e-mail address and the administrator's e-mail address do not match.	For details about how to set SMTP authentication, see "File Transfer", Settings.

**When the machine cannot be operated due to a problem with the user certificate**

Message	Cause	Solution
"The destination cannot be selected because its encryption certificate is not currently valid."	The user certificate (destination certificate) has expired.	A new user certificate must be installed. For details about the user certificate (destination certificate), see "Configuring S/MIME", Security.
"The group destination cannot be selected because it contains a destination with a encryption certificate that is not currently valid."	The user certificate (destination certificate) has expired.	A new user certificate must be installed. For details about the user certificate (destination certificate), see "Configuring S/MIME", Security.
"Transmission cannot be performed because the encryption certificate is not currently valid."	The user certificate (destination certificate) has expired.	A new user certificate must be installed. For details about the user certificate (destination certificate), see "Configuring S/MIME", Security.
"XXX cannot be YYY because the device certificate used for the S/MIME signature is not currently valid." (XXX and YYY indicate the user action.)	The device certificate (S/MIME) has expired.	A new device certificate (S/MIME) must be installed. For details about how to install a device certificate (S/MIME), see "Protecting Communication Paths via a Device Certificate", Security.

Message	Cause	Solution
"XXX cannot be YYY because there is a problem with the device certificate used for the S/MIME signature. Check the device certificate." (XXX and YYY indicate the user action.)	There is no device certificate (S/MIME), or the certificate is invalid.	For details about the device certificate (S/MIME), see "Protecting Communication Paths via a Device Certificate", Security.
"XXX cannot be YYY because the Digital Signature's device certificate is not currently valid." (XXX and YYY indicate the user action.)	The device certificate (PDF with digital signature or PDF/A with digital signature) has expired.	A new device certificate (PDF with digital signature or PDF/A with digital signature) must be installed. For details about how to install a device certificate (PDF with digital signature or PDF/A with digital signature), see "Configuring PDFs with Electronic Signatures", Security.
"XXX cannot be YYY because there is a problem with the Digital Signature's device certificate. Check the device certificate." (XXX and YYY indicate the user action.)	There is no device certificate (PDF with digital signature or PDF/A with digital signature), or the certificate is invalid.	A new device certificate (PDF with digital signature or PDF/A with digital signature) must be installed. For details about how to install a device certificate (PDF with digital signature or PDF/A with digital signature), see "Configuring PDFs with Electronic Signatures", Security.

### When problems occur while logging in

Message	Cause	Solution
"Authentication has failed."	The entered login user name or login password is not correct.	For details about the correct login user name and login password, see "Basic Authentication", Security.
"Authentication has failed."	The machine cannot perform authentication.	For details about authentication, see "Configuring User Authentication", Security.

**When the user lacks privileges to perform an operation**

Message	Cause	Solution
"You do not have the privileges to use this function."	The logged in user name does not have permissions for the selected function.	For details about how to set permissions, see "Limiting Available Functions", Security.
"The selected file(s) contained file(s) without access privileges. Only file(s) with access privileges will be deleted."	You have tried to delete files without the permission to do so.	To check your access permission for stored documents, or to delete a document you do not have permission to delete, see "Managing Stored Files", Security.

**When the LDAP server cannot be used**

Message	Cause	Solution
"Connection with LDAP server has failed. Check the server status."	A network error has occurred and connection has failed.	Try the operation again. If the message is still displayed, the network may be busy.  Check the settings for LDAP server in [System Settings]. For details about settings for LDAP server, see "Programming the LDAP Server", Settings.
"Exceeded time limit for LDAP server search. Check the server status."	A network error has occurred and connection has failed.	<ul style="list-style-type: none"> <li>• Try the operation again. If the message is still displayed, the network may be busy.</li> <li>• Check that the correct settings for LDAP server are listed in [Administrator Tools] of [System Settings]. For details about LDAP server, see "Programming the LDAP Server", Settings.</li> </ul>
"LDAP server authentication has failed. Check the settings."	A network error has occurred and connection has failed.	Configure settings correctly for the user name and the password for LDAP server authentication.



## Others

Message	Cause	Solution
"Firmware update will start. Press [OK]. It will start automatically after 30 seconds have elapsed"	Automatic firmware update is enabled and it is the time for an automatic update.	<ul style="list-style-type: none"> <li>• If you want to start the firmware update, press [OK], or configure the setting so that the automatic firmware update starts automatically in 30 seconds.</li> <li>• If you do not want to start the firmware update, press [Cancel] before 30 seconds elapse.</li> <li>• Do not turn off the power switch during the firmware update.</li> </ul>
"Cannot connect with the wireless card. Turn the main power switch off, then check the card."  (A "wireless LAN board" is referred to as a "wireless card".)	<ul style="list-style-type: none"> <li>• The wireless LAN board was not inserted when the machine was turned on.</li> <li>• The wireless LAN board was pulled out after the machine was turned on.</li> </ul> <p>The settings are not updated although the unit is detected.</p>	Turn off the power, and then check the wireless LAN board is inserted correctly. After this, turn on the power again. If the message appears again, contact your service representative.
"Failed to read the PDF file."	There is a possibility that the PDF version is not supported by the browser's PDF viewer or an unsupported encryption level is specified.	With this machine's browser PDF files other than those whose versions and encryption levels are specified below cannot be viewed. <ul style="list-style-type: none"> <li>• PDF version: 1.3-1.7</li> <li>• PDF encryption level: 128Bit AES or 256Bit AES</li> </ul>
"Clean the scanning glass. (Located next to the exposure glass.)"	The scanning glass or guide plate of the ADF is dirty.	Clean the scanning glass or guide plate. See "Maintaining Your Machine", Maintenance.
"Currently printing at low speed due to low voltage power supply."	Printing has slowed down because the power supply voltage is low.	This is not a malfunction. You can continue printing although the printing speed is low.

Message	Cause	Solution
"Following output tray is full. Remove paper."	The output tray is full.	Remove paper from the output tray to resume printing. Press [Continue] on the display panel to resume printing.
"Internal cooling fan is active."	Large print runs will cause the machine's interior to heat up, triggering the cooling fan.	<p>The fan will emit noise, but this is normal and the machine will be operable while the fan is running.</p> <p>The amount of paper that can be printed and the total operation time until the fan starts running depends on the temperature of the location at which the machine is installed.</p> <p>For people using IM 430Fb If this message appears frequently, dust may have accumulated in the ventilation holes of the printer. Check the vents, and clean the dust off. For details, see "Cleaning the Ventilation Holes", Maintenance.</p> <p>For people using IM 350F, IM 350, or IM 430F If this message appears frequently, contact your service representative.</p>
"Printing was stopped due to the power supply being low voltage. Turn the main power switch off then on."	Printing has stopped because the power supply voltage is low.	Turn off the power, and then turn it on again.
"Self checking..."	The machine is performing image adjustment operations.	The machine may perform periodic maintenance during operations. The frequency and duration of maintenance depends on the humidity, temperature, and printing factors such as number of prints, paper size, and paper type. Wait for the machine to resume operation.

Message	Cause	Solution
"Print cartridge is almost full of waste toner. Prepare print cartridge replacement. Please contact your local vender."	The waste toner in the print cartridge is almost full.	Prepare a new print cartridge.
"Print cartridge is full of waste toner. Follow the instructions on the right to replace Print Cartridge."	The waste toner in the print cartridge is almost full.	Prepare a new print cartridge.

**Note**

- If a fax or an e-mail cannot be sent and a message appears which states that there is a problem with the device certificate or user certificate, a new certificate must be installed. For details about how to install a new certificate, see "Configuring S/MIME" or "Protecting Communication Paths via a Device Certificate", Security.

# Cautions in Removing Jammed Paper

## CAUTION

- Some of the internal components of this machine might be fragile. When you remove jammed paper, do not touch the sensors, connectors, or other fragile parts that are shown in this manual. Doing so may cause malfunctions.

For the location of the sensors in the machine and extended options, see the following illustrations.

### Main unit

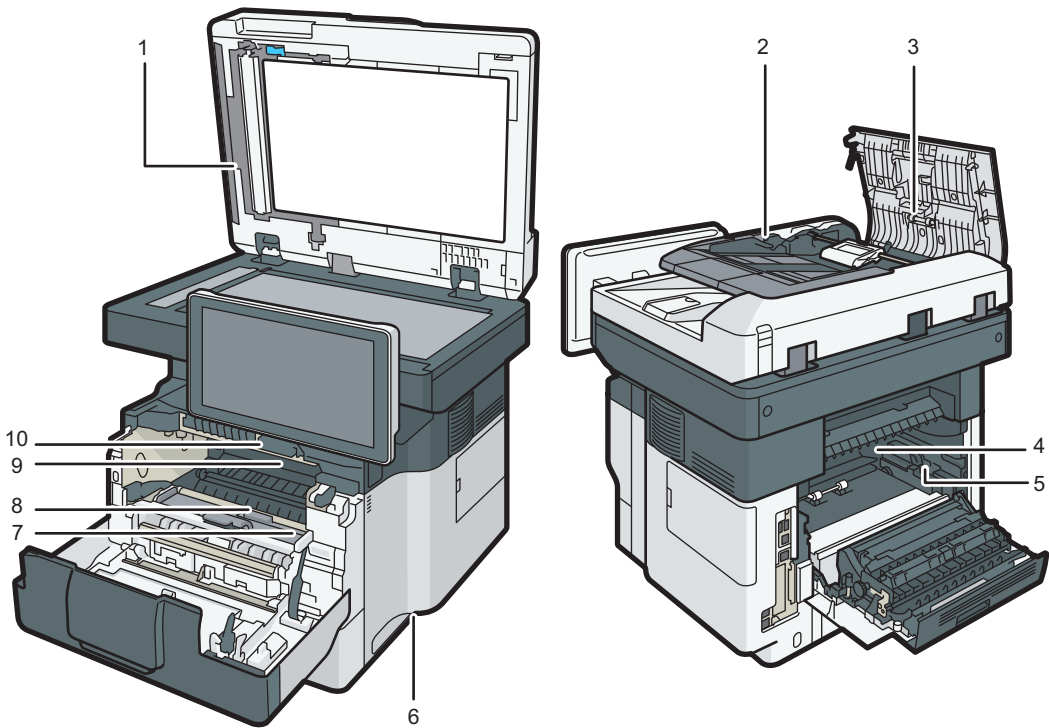

DVL501

1.

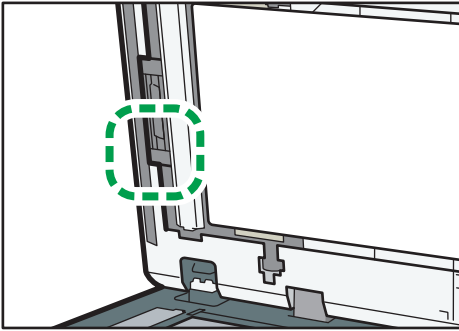

DVL503

2.

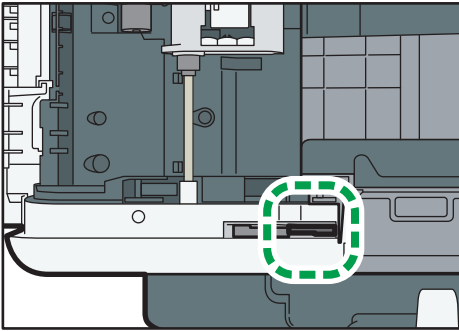

DVL504

3.

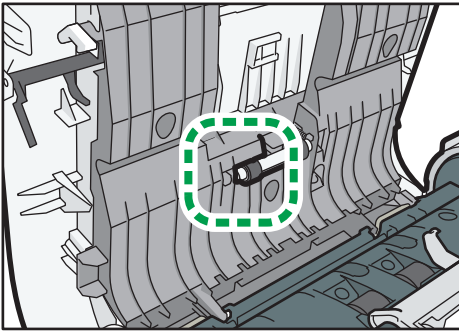

DVL506

4.

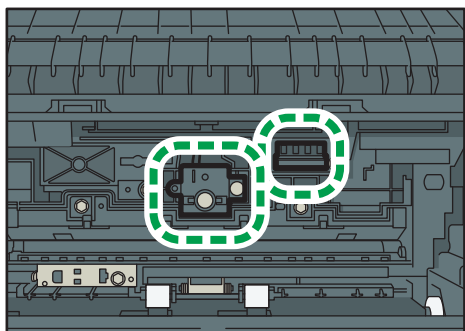

DVL507

5.

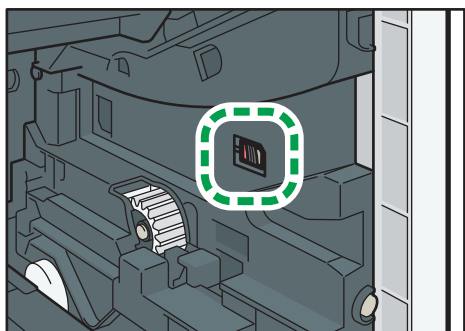

DVL508

6.

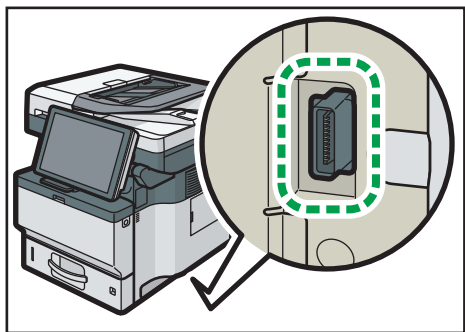

DVL509

7.

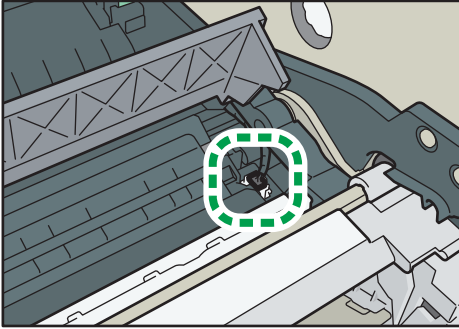

DVL510

8.

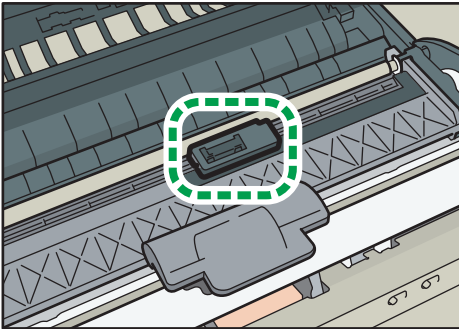

DVL511

9.

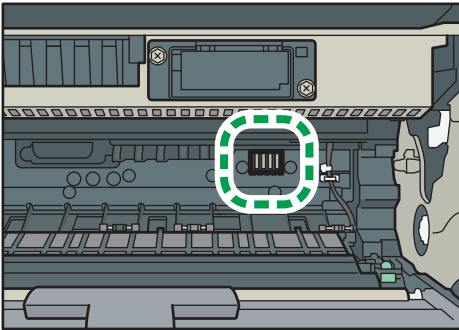

DVL512

10.

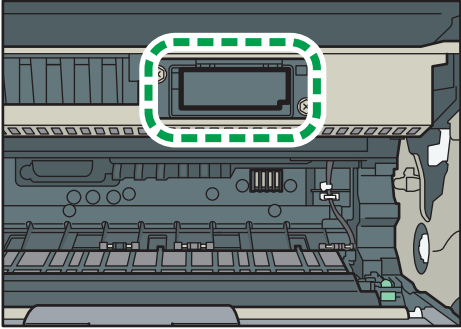

DVL513

### Tray 2, Tray 3, Tray 4

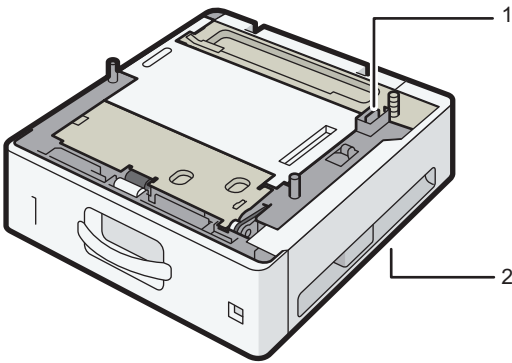

DVL520

1.

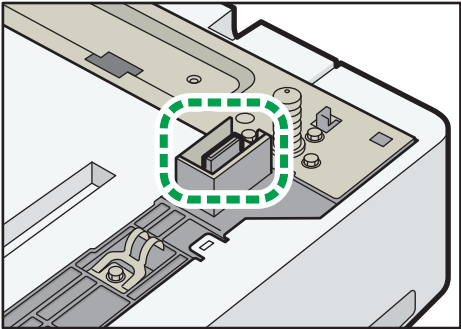

DVL521

2.



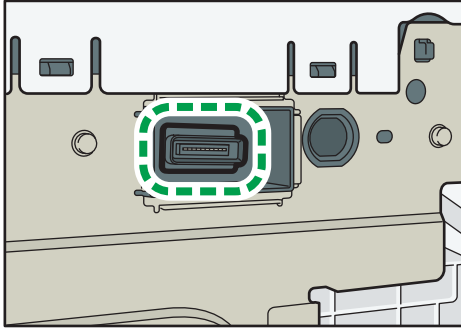

DVL522

# Removing Jammed Paper

## CAUTION

- Some of this machine's internal components get very hot. For this reason, take care when removing misfed paper. Not doing so could result in burns.
- When replacing paper or removing jammed paper, make sure not to trap or injure your fingers.
- When replacing paper or removing jammed paper, close the front cover and do these tasks one tray at a time.
- Close all the paper trays before opening the front cover to remove jammed paper or replace supplies.

## Important

- When removing paper misfeeds, do not turn off the power. If you do, the configured functions and values will be lost.
- To prevent paper misfeeds, do not leave any torn scraps of paper inside the machine.
- If paper jams continue to occur, see "When You Have Problems Operating the Machine", "When You Cannot Make Copies As Wanted", "When You Cannot Send or Receive Fax Messages As Wanted", and "Other Printing Problems", Troubleshooting for details about how to solve the problem. If the actions recommended in this manual cannot resolve the problem, contact your service representative.
- If the error message remains displayed even after you remove misfed paper, fully open the front cover, and then close it.
- Some of this machine's internal components get very hot. Before removing jammed paper from the fusing unit, leave the machine for some time until the covers of the fusing unit and duplex unit get cool.
- The metallic parts of the internal tray may get very hot immediately after printing. Do not touch the metallic part.
- When removing jammed paper, you can touch only those areas explicitly indicated in the manual.
- After you open the rear cover and remove jammed paper from the fusing unit, the next document that you print may get dirty. You may need to print that document again.
- Before removing jammed paper from the bypass tray, first remove the paper loaded in the bypass tray.

## Note

- If a detailed removal instruction appears on the right of the screen, follow it.
- You can also use the procedure indicated in the [Check Status] screen to remove jammed paper.

## Locating Jammed Paper

If a misfeed occurs, remove the jammed paper by following the procedures indicated in the animation that appears on the screen and the sticker or sheet inside the front cover.

A misfeed has occurred in the place corresponding to the letter displayed on the control panel.

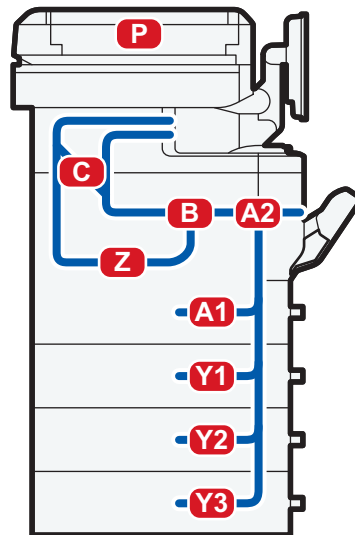

DVL523

1. Remove the jammed paper by following the procedures that are displayed on the screen.

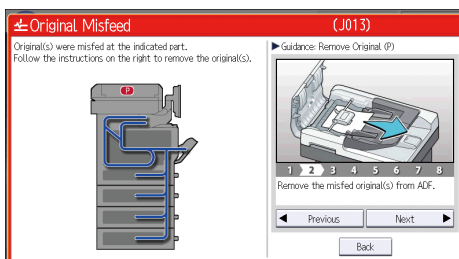

- When [Next] or [Previous] is displayed on the screen.

After each step is complete, press [Next]. To go back to the previous step, press [Previous].

2. When the jammed paper is removed, restore the machine to the original state.

### ↓ Note

- Multiple paper misfeed locations may be indicated at the same time. When this happens, check all the areas indicated.
- If there is no misfed paper in the area you check first, see the other areas that are indicated.



# 10. Information for This Machine

This chapter describes environmental precautions and regulations.

## ENERGY STAR Program

### ENERGY STAR® Program Requirements for Imaging Equipment



This company is a participant in the ENERGY STAR® Program.  
This machine is compliant with the regulations specified by the ENERGY STAR® Program.

The ENERGY STAR® Program Requirements for Imaging Equipment encourage energy conservation by promoting energy efficient computers and other office equipment.

The program backs the development and dissemination of products that feature energy saving functions.

It is an open program in which manufacturers participate voluntarily.

Targeted products are computers, monitors, printers, facsimiles, copiers, scanners, and multi-function devices. Energy Star standards and logos are internationally uniform.

## Energy Saving Functions

To reduce its power consumption, this machine has the following functions:

### Sleep mode

- If this machine remains idle for a specified period or when [Energy Saver] () is pressed, it enters Sleep mode to further reduce its electrical consumption.
- The default delay time the machine waits before entering Sleep mode is 1 minute. This default time can be changed.
- The machine can print jobs from computers and receive faxes while in Sleep mode.

### Specification

-  **Region A** (mainly Europe and Asia)

	Specification
Reduced electrical consumption in Sleep mode <sup>*1</sup>	0.79 W
Time of switch into Sleep mode	1 minute
Time of switch out from Sleep mode <sup>*1</sup>	<ul style="list-style-type: none"> <li>• IM 350F/IM 350 9.0 seconds</li> <li>• IM 430F 9.5 seconds</li> </ul>
Duplex Function <sup>*2</sup>	Standard

<sup>\*1</sup> The time it takes to switch out from energy saving functions and electrical consumption may differ depending on the conditions and environment of the machine.

<sup>\*2</sup> Achieves ENERGY STAR energy savings; product fully qualifies when packaged with (or used with) a duplex tray and the duplex function is enabled as an option.

-  **Region B** (mainly North America)

	Specification
Reduced electrical consumption in Sleep mode <sup>*1</sup>	0.74 W
Time of switch into Sleep mode	1 minute

	Specification
Time of switch out from Sleep mode <sup>*1</sup>	<ul style="list-style-type: none"> <li>• IM 350F 8.7 seconds</li> <li>• IM 430Fb/IM 430F 9.4 seconds</li> </ul>
Duplex Function <sup>*2</sup>	Standard

\*1 The time it takes to switch out from energy saving functions and electrical consumption may differ depending on the conditions and environment of the machine.

\*2 Achieves ENERGY STAR energy savings; product fully qualifies when packaged with (or used with) a duplex tray and the duplex function is enabled as an option.

#### ↓ Note

- Specifications can vary depending on which options are installed on the machine.
- For details about how to change the default interval, see "Timer Settings", Settings.
- Depending on which embedded software application is installed on it, the machine might take longer than indicated to enter Sleep mode.

## User Information on Electrical and Electronic Equipment Region **A** (mainly Europe)

---

**Users in the countries where this symbol shown in this section has been specified in national law on collection and treatment of E-waste**

---

Our Products contain high quality components and are designed to facilitate recycling.

Our products or product packaging are marked with the symbol below.



The symbol indicates that the product must not be treated as municipal waste. It must be disposed of separately via the appropriate return and collection systems available. By following these instructions you ensure that this product is treated correctly and help to reduce potential impacts on the environment and human health, which could otherwise result from inappropriate handling. Recycling of products helps to conserve natural resources and protect the environment.

For more detailed information on collection and recycling systems for this product, please contact the shop where you purchased it, your local dealer or sales/service representatives.

---

### All Other Users

---

If you wish to discard this product, please contact your local authorities, the shop where you bought this product, your local dealer or sales/service representatives.

---

### For Users in India

---

This product including components, consumables, parts and spares complies with the "India E-waste Rule" and prohibits use of lead, mercury, hexavalent chromium, polybrominated biphenyls or polybrominated diphenyl ethers in concentrations exceeding 0.1 weight % and 0.01 weight % for cadmium, except for the exemptions set in the Rule.



---

## For Turkey Only

---

AEEE Yönetmeliğine Uygundur.

Bu sistem sarf malzemeleri ve yedek parçaları da dahil olmak üzere AEEE Yönetmeliğine Uygundur.

### Üretici:

Ricoh Company, Ltd.

3-6, Nakamagome 1-chome,

Ohta-ku, Tokyo 143-8555 Japan

+81-3-3777-8111(English only/Sadece İngilizce)

## Note for the Battery and/or Accumulator Symbol (For EU countries only) Region **A** (mainly Europe)



In accordance with the Battery Directive 2006/66/EC Article 20 Information for end-users Annex II, the above symbol is printed on batteries and accumulators.

This symbol means that in the European Union, used batteries and accumulators should be disposed of separately from your household waste.

In the EU, there are separate collection systems for not only used electrical and electronic products but also batteries and accumulators.

Please dispose of them correctly at your local community waste collection/recycling centre.

# Environmental Advice for Users Region A (mainly Europe)

## Users in the EU, Switzerland and Norway

### Consumables yield

Please refer to either the User's Manual for this information or the packaging of the consumable.

### Recycled paper

The machine can use recycled paper which is produced in accordance with European standard EN 12281:2002 or DIN 19309. For products using EP printing technology, the machine can print on 64 g/m<sup>2</sup> paper, which contains less raw materials and represents a significant resource reduction.

### Duplex printing (if applicable)

Duplex printing enables both sides of a sheet of paper to be used. This saves paper and reduces the size of printed documents so that fewer sheets are used. We recommend that this feature is enabled whenever you print.

### Toner and ink cartridge return program

Toner and ink cartridge for recycling will be accepted free of charge from users in accordance with local regulations.

For details about the return program, please refer to the Web page below or consult your service person.

<https://www.ricoh-return.com/>

### Energy efficiency

The amount of electricity a machine consumes depends as much on its specifications as it does on the way you use it. The machine is designed to allow you to reduce electricity costs by switching to Ready mode after it prints the last page. If required, it can immediately print again from this mode. If no additional prints are required and a specified period of time passes, the device switches to an energy saving mode.

In these modes, the machine consumes less power (watts). If the machine is to print again, it needs a little longer to return from an energy saving mode than from Ready mode.

For maximum energy savings, we recommend that the default setting for power management is used.

## Notes to users in the state of California (Notes to Users in USA) Region **B** (mainly North America)

Perchlorate Material - special handling may apply. See: [www.dtsc.ca.gov/hazardouswaste/perchlorate](http://www.dtsc.ca.gov/hazardouswaste/perchlorate)

# Specifications for the Main Unit

## Configuration:

Desktop

## Hard disk

320 GB or more

## Photosensitivity type:

OPC drum

## Original scanning:

One-dimensional solid scanning through CCD

CIS sensor is also used for scanning back side of ADF

## Copy process:

LED alley and electro-photographic printing

## Development:

Dry two-component magnetic brush development system

## Fusing:

Heating roll pressure system

## Resolution:

- Scanning:  
Exposure glass: 600 × 600 dpi  
ADF: 600 × 300 dpi (front), 300 × 600 dpi (back), 600 × 600 dpi
- Printing:  
1200 × 1200dpi

## Exposure glass:

Stationary original exposure type

## Original reference position:

Rear left corner

## Warm-up time (23 °C (73.4 °F), rated voltage)

-  **Region A** (mainly Europe and Asia)

	IM 350F	IM 350	IM 430F
Normal mode	47.4 seconds	47.4 seconds	49.3 seconds
Quick mode	21.5 seconds	21.5 seconds	22.4 seconds

-  **Region B** (mainly North America)

	IM 350F	IM 430Fb	IM 430F
Normal mode	47.6 seconds	57.8 seconds	57.8 seconds
Quick mode	23.1 seconds	24.0 seconds	24.0 seconds

The warm-up time may differ depending on the operating environment of the machine.

### Originals:

Sheet, book, three-dimensional object, ID card

### Maximum original size:

216 × 356 mm (8.5 × 14 inches)

### Paper size:

- Tray 1 and the bypass tray:  
For details, see page 186 "Recommended Paper".
- Duplex:  
A4<sup>□</sup>, A5<sup>□</sup>, A6<sup>□</sup>, B5<sup>□</sup>, B6<sup>□</sup>, 8<sup>1</sup>/<sub>2</sub> × 14<sup>□</sup>, 8<sup>1</sup>/<sub>2</sub> × 13<sup>□</sup>, 8<sup>1</sup>/<sub>2</sub> × 11<sup>□</sup>, 8<sup>1</sup>/<sub>4</sub> × 14<sup>□</sup>, 8<sup>1</sup>/<sub>4</sub> × 13<sup>□</sup>, 8 × 13<sup>□</sup>, 8 × 10<sup>1</sup>/<sub>2</sub><sup>□</sup>, 8 × 10<sup>□</sup>, 7<sup>1</sup>/<sub>4</sub> × 10<sup>1</sup>/<sub>2</sub><sup>□</sup>, 5<sup>1</sup>/<sub>2</sub> × 8<sup>1</sup>/<sub>2</sub><sup>□</sup>, 16K<sup>□</sup>, 8<sup>1</sup>/<sub>2</sub> × 13<sup>2</sup>/<sub>5</sub><sup>□</sup>
- Duplex (custom size):  
Vertical: 148–356 mm (5.83–14.01 inches)  
Horizontal: 100–216 mm (3.94–8.50 inches)  
If the paper has a horizontal width of more than 297.0 mm, feed the paper from a paper tray unit.

### Paper weight:

- Trays 1 and the bypass tray: For details, see page 186 "Recommended Paper".
- Duplex: 52–162 g/m<sup>2</sup> (14 lb. Bond–90 lb. Index)

For details about and recommendations concerning thick paper, see page 192 "When Loading Thick Paper".

### Missing image area (Copier):

For details, see "Maximum Scan Area and Missing Image Area", For First-time Users.

### First copy time:

-  **Region A** (mainly Europe and Asia)

IM 350F	IM 350	IM 430F
6.5 seconds	6.5 seconds	5.9 seconds

-  **Region B** (mainly North America)

IM 350F	IM 430Fb	IM 430F
6.4 seconds	5.8 seconds	5.8 seconds

(A4□, 8<sup>1</sup>/<sub>2</sub> × 11□, 100% reproduction, feeding from Tray 1, on the exposure glass)

#### First print time:

-  **Region A** (mainly Europe and Asia)

IM 350F	IM 350	IM 430F
5.4 seconds	5.4 seconds	4.5 seconds

-  **Region B** (mainly North America)

IM 350F	IM 430Fb	IM 430F
5.4 seconds	4.5 seconds	4.5 seconds

The first print time may differ depending on the operating environment of the machine.

#### Copy/print speed:

- IM 350F/IM 350
  - A4□, 35 sheets/minute
  - 8<sup>1</sup>/<sub>2</sub> × 11□, 37 sheets/minute
- IM 430Fb/IM 430F
  - A4□, 43 sheets/minute
  - 8<sup>1</sup>/<sub>2</sub> × 11□, 45 sheets/minute

#### Reproduction ratio:

-  **Region A** (mainly Europe and Asia)

Preset reproduction ratios (%):

- Enlargement: 200, 141
- Full size: 100
- Reduction: 93, 71, 50

-  **Region B** (mainly North America)

Preset reproduction ratios (%):

- Enlargement: 155, 129
- Full size: 100
- Reduction: 93, 78, 65

- Zoom: From 25–400% in increments of 1%



### Maximum continuous copy run:

999 sheets

### Paper capacity (80 g/m<sup>2</sup>, 20 lb. Bond):

For details, see page 186 "Recommended Paper".

### Power requirements:

-  **Region A** (mainly Europe and Asia)  
220–240 V, 7 A, 50/60 Hz
-  **Region B** (mainly North America)  
120–127 V, 12 A, 60 Hz

### Power consumption

-  **Region A** (mainly Europe and Asia)
  - Main unit only

	IM 350F/IM 350	IM 430F
Ready	91.5 W	91.5 W
During printing	562 W	625 W
Maximum	1280 W	1290 W

The power level when the main switch is turned off and the power cord is plugged into an outlet: 1 W or less

- Complete system

	IM 350F/IM 350	IM 430F
Maximum	1280 W or less	1290 W or less

The complete system consists of the main unit, ADF, lower paper trays (three unit), Copy Data Security unit, HDD, fax unit, memory unit.

-  **Region B** (mainly North America)
  - Main unit only

	IM 350F	IM 430Fb/IM 430F
Ready	91.0 W	91.0 W
During printing	566 W	628 W



	IM 350F	IM 430Fb/IM 430F
Maximum	1380 W	1390 W

The power level when the main switch is turned off and the power cord is plugged into an outlet: 1 W or less

- Complete system

	IM 350F	IM 430Fb/IM 430F
Maximum	1380 W or less	1390 W or less

The complete system consists of the main unit, ADF, lower paper trays (three unit), Copy Data Security unit, HDD, fax unit, memory unit.

#### Dimensions:

- W × D × H up to ADF:  
476 × 442 × 510 mm (18.7 × 17.4 × 20.0 inches)

#### Space for main unit (W × D):

544 × 727 mm (21.4 × 28.6 inches) (including the bypass tray, rear cover, and offline stapler)

#### Noise emission

- Sound power level:
  - Main unit only

	IM 350F/IM 350	IM 430Fb/IM 430F
Stand-by	30.6 dB (A)	29.6 dB (A)
Copying	60.1 dB (A)	62.0 dB (A)

- Complete system

	IM 350F/IM 350	IM 430Fb/IM 430F
Stand-by	30.2 dB (A)	30.0 dB (A)
Copying	66.6 dB (A)	65.9 dB (A)

- Sound pressure level:
  - Main unit only

	IM 350F/IM 350	IM 430Fb/IM 430F
Stand-by	23.9 dB (A)	25.2 dB (A)
Copying	52.0 dB (A)	54.3 dB (A)

- Complete system

	IM 350F/IM 350	IM 430Fb/IM 430F
Stand-by	20.4 dB (A)	20.3 dB (A)
Copying	56.0 dB (A)	57.1 dB (A)

- Sound power level and sound pressure level are actual values measured in accordance with ISO 7779.
- Sound pressure level is measured from the position of the bystander.
- The complete system consists of the main unit and three paper tray units.

### Weight

- Approx. 30.5 kg (67.3 lb.) (Main unit only, including consumables.)

#### Note

- We have obtained each author's permission for the use of applications including open-source software applications. For details about the copyright information for these software applications, see the file in the OSS folder on the CD-ROM supplied with the machine.

# Specifications for the Document Server

## **HDD (Document Server):**

Approx. 38 GB

Maximum: 9,000 pages

(Total number of pages that can be accommodated stored with all functions combined.)

Copier/A4 original: Approx. 9,000 pages

Printer/A4/600 dpi, 1 bit: Approx. 9,000 pages

Scanner/Full Color/A4/200 dpi, 8 bits/JPEG: Approx. 9,000 pages

(Under the printer and scanner modes, the number of the pages that can be stored depends on the print image and original.)

## **Maximum number of stored documents:**

3,000 documents

## **Number of pages supported by memory sorting:**

Maximum: 2,000 pages

Copier/A4 original: Approx. 2,000 pages

Printer/A4/600 dpi, 4 bits: Approx. 2,000 pages

(Under the printer mode, the number of the pages that can be sorted depends on the print image.)

# Specifications for Facsimile

---

## Fax Transmission and Reception

---

**Standard:**

G3

**Resolution:**

8 × 3.85 lines/mm, 200 × 100 dpi (Standard character), 8 × 7.7 lines/mm, 200 × 200 dpi (Detail character)

**Transmission time:**

3 seconds at 28,800 bps, Standard resolution (JBIG transmission: 2 seconds)

**Data compression method:**

MH, MR, MMR, JBIG

**Maximum original size:**

Standard: A4☐, 8<sup>1</sup>/<sub>2</sub> × 14☐

Custom: 297 × 600 mm (11.7 × 23.6 inches)

**Maximum scanning size:**

216 × 600 mm (8.5 × 23.6 inches)

**Print process:**

LED alley and electro-photographic printing

**Transmission speed:**

33,600/31,200/28,800/26,400/24,000/21,600/19,200/16,800/14,400/12,000/9,600/7,200/4,800/2,400 bps (auto shift down system)

10

---

## IP-Fax Transmission and Reception

---

**Network:**

- Standard: Ethernet interface (1000BASE-T/100 BASE-TX/10 BASE-T). The maximum length for the cable is 100 meters.
- Optional: IEEE 802.11a/b/g/n wireless LAN interface

**Scan line density:**

8 × 3.85 lines/mm, 200 × 100 dpi (Standard character), 8 × 7.7 lines/mm, 200 × 200 dpi (Detail character)

**Maximum original size:**

Standard: A4, 8<sup>1</sup>/<sub>2</sub> × 14

Custom: 297 × 600 mm (11.7 × 23.6 inches)

**Maximum scanning size:**

216 × 600 mm (8.5 × 23.6 inches)

**Transmission protocol:**

Recommendation: T.38, TCP, UDP/IP communication, SIP (RFC 3261 compliant), H.323 v2

**Compatible machines:**

IP-Fax compatible machines

**IP-Fax transmission function:**

Specify an IP address and send faxes to an IP-Fax compatible fax through a network.

Also capable of sending faxes to a G3 fax connected to a telephone line via a VoIP gateway.

**IP-Fax reception function:**

Receive faxes sent from an IP-Fax compatible fax through a network.

Also capable of receiving faxes from a G3 fax connected to a telephone line via a VoIP gateway.

---

## Internet Fax Transmission and Reception

---

**Network:**

- Standard: Ethernet interface (1000BASE-T/100 BASE-TX/10 BASE-T). The maximum length for the cable is 100 meters.
- Optional: IEEE 802.11a/b/g/n wireless LAN interface

**Transmit function:**

E-mail

**Scan line density:**

200 × 100 dpi (Standard character)<sup>\*1</sup>, 200 × 200 dpi (Detail character)

**Original size : Scanning width:**

A4

**Communication Protocols:**

- Transmission  
SMTP, TCP/IP
- Reception  
POP3, SMTP, IMAP4, TCP/IP

**E-mail format:**

Single/Multi-part, MIME Conversion

Attached file forms: TIFF-F (MH, MR<sup>\*1</sup>, MMR<sup>\*1</sup> compression)

**Authentication method:**

SMTP-AUTH, POP before SMTP, A-POP

**Internet communication:**

Send and receive e-mail with a computer that has an e-mail address

**Encryption method (for forwarding) :**

S/MIME

**Internet Fax send functions:**

Automatic conversion of sent documents to e-mail format and e-mail transmission. Memory transmission only.

**Internet Fax receive functions:**

Automatic detection and printing of appended TIFF-F (MH) files and ASCII text. Memory reception only.

\*1 Full mode

---

## E-mail Transmission and Reception, and Folder Transmission

---

**Network:**

- Standard: Ethernet interface (1000BASE-T/100 BASE-TX/10 BASE-T). The maximum length for the cable is 100 meters.
- Optional: IEEE 802.11a/b/g/n wireless LAN interface

**Scan line density:**

200 × 100 dpi (Standard character)<sup>\*1</sup>, 200 × 200 dpi (Detail character)

**Maximum original size:**

Standard: A4□, 8<sup>1</sup>/<sub>2</sub> × 14□

Custom: 297 × 600 mm (11.7 × 23.6 inches)

**Maximum scanning size:**

216 × 600 mm (8.5 × 23.6 inches)

**E-mail reception/transmission protocols:**

- Transmission  
SMTP, TCP/IP
- Reception (Mail to Print)

POP3, SMTP, IMAP4, TCP/IP

**Protocols for sending files to folders:**

SMB, FTP, TCP/IP

**E-mail formats:**

Single/Multi-part, MIME Conversion

**File formats:**

- Transmission  
TIFF (MH, MR, MMR compression), PDF, PDF/A

When you select [PDF] or [PDF/A] for the file format, you can attach a digital signature. For details about how to attach a digital signature, see "Selecting the File Format for Documents for Fax Transmission", Fax.

- Reception (Mail to Print)  
JPEG (JFIF), PDF

**Authentication methods:**

SMTP-AUTH, POP before SMTP, A-POP

**Encryption method:**

S/MIME

**E-mail sending functions:**

Automatically converts documents to e-mail format and sends them as e-mail.

**E-mail receiving functions:**

Automatically detects and prints JPEG and PDF documents attached to received e-mail.

**Sending to folder functions:**

Sends scanned files over the network to shared folders or FTP server folders.

\* 1 When you send document in TIFF format.

# Specifications for Printer

## Resolution:

200 dpi, 300 dpi, 400 dpi, 600 dpi, 1200 dpi

## Printing speed:

- IM 350F/IM 350
  - A4 $\square$ , 35 sheets/minute
  - 8 $\frac{1}{2}$  × 11 $\square$ , 37 sheets/minute
- IM 430Fb/IM 430F
  - A4 $\square$ , 43 sheets/minute
  - 8 $\frac{1}{2}$  × 11 $\square$ , 45 sheets/minute

Printing speeds depend on the machine. Check which type of machine you have. See Read This First.

## Interface:

Standard:

- Ethernet interface (1000BASE-T/100BASE-TX/10BASE-T). The maximum length for the cable is 100 meters.
- USB 2.0 (Type A) port (on the control panel)
- SD card slot (on the control panel)

Option:

- IEEE 1284 parallel interface
- IEEE 802.11 a/b/g/n wireless LAN interface
- Extended USB board
- USB device server

## Network protocol:

TCP/IP (IPv4, IPv6)

## Printer language:

- Standard: PJI, RPCS, PCL5e/XL, MediaPrint: JPEG, MediaPrint: TIFF, IRIPS PS3, IRIPS PDF Direct
- Option: Adobe PS3, Adobe PDE Direct, IPDS, XPS

## Fonts:

- PCL 5e: 93 fonts
- PDF: 93 fonts
- PostScript 3: 93 fonts



**Memory:**

2 GB

**USB interface:**

- Supported operating system:  
Windows 7/8.1/10, Windows Server 2008/2008 R2/2012/2012 R2/2016/2019,  
OS X 10.11 or later
- Transmission spec:  
USB 2.0 Standard
- Connectable device:  
Devices corresponding to USB 2.0 Standard

**Note**

- When you are using silent mode, the print speed may be slower.

# Specifications for Scanner

## Type:

Full-color scanner

## Scan method:

Flatbed scanning

## Image sensor type:

Front side: CCD Image Sensor

Back side: Contact Image Sensor

## Scan type:

Sheet, book, three-dimensional object, ID card

## Original sizes that can be scanned:

- Length  
10–216 mm (0.4–8.5 inches)
- Width  
Exposure glass: 10–356 mm (0.4–14.0 inches)  
ADF: 10–600 mm (0.4–23.6 inches)

## Scan speed:

When using the E-mail, Scan to Folder, WSD (Push Type), or Scan to Removable device (Original size: A4 $\square$ /8 $\frac{1}{2}$  × 11 $\square$ , Resolution: 200 dpi/300 dpi):

- Black and white: 40 pages/minute  
(Original Type: B & W: Text / Line Art, Compression (Black & White): MH, ITU-T No1 Chart)
- Full Color: 40 pages/minute (300 dpi), 40 pages/minute (200 dpi)  
(Original Type: Full Color: Text / Photo, Compression (Gray Scale / Full Color): Default, Original Chart)

Scanning speed differs depending on the following; operating environment of the machine and computer, scan settings, and the content of originals (denser images require more time).

## Tone:

Black and white: 2 tones

Full color / Gray scale: 256 tones

## Basic scanning resolution:

200 dpi

## Image compression type for black and white (two-value):

TIFF (MH, MR, MMR, JBIG2)

**Image compression type for gray scale/full color:**

JPEG

**Interface:**

Standard

- Ethernet interface (1000BASE-T/100BASE-TX/10BASE-T). The maximum length for the cable is 100 meters.
- USB 2.0 (Type A) port (on the control panel)
- SD card slot (on the control panel)

Option:

- IEEE 802.11 a/b/g/n wireless LAN interface

**Network protocol:**

TCP/IP

**Selectable scanning resolutions when using the E-mail function:**

100 dpi, 200 dpi, 300 dpi, 400 dpi, 600 dpi

**Protocol for sending e-mail:**

SMTP

**Sendable file formats when using the E-mail function:**

TIFF, JPEG, PDF, High Compression PDF, PDF/A

When you select [PDF], [High Compression PDF], or [PDF/A] for the file format, you can attach a digital signature. You can also specify the security settings for [PDF] or [High Compression PDF]. For details, see "Specifying Digital Signature for PDF files", "Security Settings for PDF Files", Scan.

**Selectable scanning resolutions when using the Scan to Folder function:**

100 dpi, 200 dpi, 300 dpi, 400 dpi, 600 dpi

**Protocol for Scan to Folder:**

SMB, FTP

**Sendable file formats when using the Scan to Folder function:**

TIFF, JPEG, PDF, High Compression PDF, PDF/A

When you select [PDF], [High Compression PDF], or [PDF/A] for the file format, you can attach a digital signature. You can also specify the security settings for [PDF] or [High Compression PDF]. For details, see "Specifying Digital Signature for PDF files", "Security Settings for PDF Files", Scan.

**WSD**

Supported.

**DSM**

Supported.

**Selectable scanning resolution when using TWAIN scanner:**

- When using the exposure glass: 100–1,200 dpi
- When using the ADF: 100–600 dpi

**Protocol for TWAIN scanner:**

TCP/IP

**Operating system for TWAIN scanner:**

Windows 7/8.1/10, Windows Server 2008/2008 R2/2012/2012 R2/2016/2019

(TWAIN scanner runs in 32-bit compatible mode on a 64-bit operating system, so TWAIN scanner is not compatible with 64-bit applications. Use it with 32-bit applications.)

**Selectable scanning resolutions when using WIA scanner:**

100–1,200 dpi

**Protocol for WIA scanner:**

TCP/IP

**Operating system for WIA scanner:**

Windows 7/8.1/10, Windows Server 2008/2008 R2/2012/2012 R2/2016/2019

(WIA scanner can function under both 32- and 64-bit operating systems.)

**Note**

- Specifications are subject to change without notice.

# Specifications for Lower Paper Tray (250 sheets)

**Paper size:**

A4, A5, A6, B5 JIS, B6 JIS, 8<sup>1</sup>/<sub>2</sub> × 14, 8<sup>1</sup>/<sub>2</sub> × 13, 8<sup>1</sup>/<sub>2</sub> × 11, 8<sup>1</sup>/<sub>4</sub> × 14, 8<sup>1</sup>/<sub>4</sub> × 13, 8 × 13, 8 × 10<sup>1</sup>/<sub>2</sub>, 8 × 10, 7<sup>1</sup>/<sub>4</sub> × 10<sup>1</sup>/<sub>2</sub>, 5<sup>1</sup>/<sub>2</sub> × 8<sup>1</sup>/<sub>2</sub>, 8<sup>1</sup>/<sub>2</sub> × 13<sup>2</sup>/<sub>5</sub>, 16K, custom size

**Paper weight:**

52-220 g/m<sup>2</sup> (14 lb. Bond-80 lb. Index)

**Paper capacity (80 g/m<sup>2</sup>, 20 lb. Bond):**

250 sheets × 1 tray

**Power consumption:**

17 W or less (Power is supplied from the main unit.)

**Dimensions (W × D × H):**

370 × 392 × 95 mm (14.6 × 15.4 × 3.7 inches)

**Weight:**

Approx. 4.8 kg (10.6 lb.)

## Specifications for Lower Paper Tray (500 sheets)

### Paper size:

A4, A5, A6, B5 JIS, B6 JIS,  $8\frac{1}{2} \times 14$ ,  $8\frac{1}{2} \times 13$ ,  $8\frac{1}{2} \times 11$ ,  $8\frac{1}{4} \times 14$ ,  $8\frac{1}{4} \times 13$ ,  $8 \times 13$ ,  $8 \times 10\frac{1}{2}$ ,  $8 \times 10$ ,  $7\frac{1}{4} \times 10\frac{1}{2}$ ,  $5\frac{1}{2} \times 8\frac{1}{2}$ ,  $8\frac{1}{2} \times 13\frac{2}{5}$ , 16K, custom size

### Paper weight:

52-220 g/m<sup>2</sup> (14 lb. Bond-80 lb. Index)

### Paper capacity (80 g/m<sup>2</sup>, 20 lb. Bond):

500 sheets × 1 tray

### Power consumption:

17 W or less (Power is supplied from the main unit.)

### Dimensions (W × D × H):

370 × 392 × 125 mm (14.6 × 15.4 × 4.9 inches)

### Weight:

Approx. 5.5 kg (12.1 lb.)

# Specifications for IEEE 1284 Interface Board

## ★ Important

- Do not use an IEEE 1284 cable that is longer than 3 meters.

### Transmission spec.:

IEEE 1284

### Required cable:

Standard IEEE 1284 compliant Micro Centronics 36 pin cable

# Specifications for Wireless LAN Interface Board

## ★ Important

- Note that the available channels (frequency ranges) and locations to use the wireless LAN are subject to the regulations of the country or region where the printer is used. Be sure to use the wireless LAN according to the applicable regulations.

### Transmission spec.:

Based on IEEE 802.11a/b/g/n (wireless LAN)

### Protocol:

TCP/IP

### Transmission Rate:

- 2.4 GHz band: 1–130 Mbps
- 5 GHz band: 1–300 Mbps

### Frequency range (Center Frequency):

- 2412–2472 MHz (1–13 channels)
- 5180–5320 MHz (36, 40, 44, 48, 52, 56, 60, and 64 channels)
- 5500–5700 MHz (100, 104, 108, 112, 116, 120, 124, 128, 132, 136 and 140 channels)

### Ad-hoc mode Channel Frequency range (Center Frequency):

- 2412–2462 MHz (1–11 channels)
- 5180–5240 MHz (36, 40, 44, and 48 channels)

### Transmission mode:

- Ad hoc mode
- Infrastructure mode
- Direct Connection Mode
- Direct Connection: Group Owner Mode

## ↓ Note

- Web Image Monitor is supported.
- The transmission rates of 300 Mbps in the 5 GHz band and 130 Mbps in the 2.4 GHz band are theoretical values of the wireless LAN specification. The actual transmission rate may be lower, depending on the operating environment.
- The maximum transmission rate in the ad-hoc mode is 54 Mbps for IEEE802.11a and 11 Mbps for IEEE802.11b. The Ad-hoc communication is not supported in an IEEE802.11g/n environment.



- Channels other than 1–11 and 36–52 cannot be used because of the specifications and the configuration of the access point.
- The channel in use might differ depending on the country.

# Specifications for Auto Document Feeder

## Mode:





 **Region A** (mainly Europe and Asia)

- Batch mode, Original Orientation mode, and Custom Size originals mode

 **Region B** (mainly North America)

- Batch mode, LT/LG Mixed Sizes mode, Original Orientation mode, and Custom Size originals mode

## Original size:

A4 -B6 JIS , 8 1/2 × 14 -5 1/2 × 8 1/2  

## Original weight:

52-128 g/m<sup>2</sup> (14-34 lb. Bond)

## Number of originals to be set:

- 50 sheets (80 g/m<sup>2</sup>, 20 lb. Bond or less)
- 20 sheets (more than 80 g/m<sup>2</sup>, 20 lb. Bond)

## Power Requirements

Power is supplied from the main unit.

# Specifications for USB Device Server

**Interfaces:**

- Gigabit Ethernet (10BASE-T/100BASE-TX/1000BASE-T)
- USB 2.0 (For connecting the printer and the print server interface)

**Operating Systems:**

- Windows 7/8.1/10, Windows Server 2008/2008 R2/2012/2012 R2/2016/2019
- OS X 10.11 or later

**Protocols:**

- The USB device server supports Port 9100, IPP, and LPR only. IPP does not support SSL.
- The USB device server allows simultaneous connection of up to 8 sessions of printing protocols.

# Copyright Information about Installed Applications

Flex carries the copyright used for BSD software, slightly modified because it originated at the Lawrence Berkeley (not Livermore!) Laboratory, which operates under a contract with the Department of Energy:

Copyright (c) 2001, 2002, 2003, 2004, 2005, 2006, 2007 The Flex Project.

Copyright (c) 1990, 1997 The Regents of the University of California.

All rights reserved.

This code is derived from software contributed to Berkeley by Vern Paxson.

The United States Government has rights in this work pursuant to contract no. DE-AC03-76SF00098 between the United States Department of Energy and the University of California.

Redistribution and use in source and binary forms, with or without modification, are permitted provided that the following conditions are met:

1. Redistributions of source code must retain the above copyright notice, this list of conditions and the following disclaimer.
2. Redistributions in binary form must reproduce the above copyright notice, this list of conditions and the following disclaimer in the documentation and/or other materials provided with the distribution.

Neither the name of the University nor the names of its contributors may be used to endorse or promote products derived from this software without specific prior written permission.

THIS SOFTWARE IS PROVIDED "AS IS" AND WITHOUT ANY EXPRESS OR IMPLIED WARRANTIES, INCLUDING, WITHOUT LIMITATION, THE IMPLIED WARRANTIES OF MERCHANTABILITY AND FITNESS FOR A PARTICULAR PURPOSE.

This basically says "do whatever you please with this software except remove this notice or take advantage of the University's (or the flex authors') name".

Note that the "flex.sk1" scanner skeleton carries no copyright notice.

You are free to do whatever you please with scanners generated using flex; for them, you are not even bound by the above copyright.

# INDEX

## A

Ad hoc Mode..... 23  
Adding toner.....196  
Address Book.111, 114, 150, 152, 153, 154, 156,  
158, 254  
ADF.....9, 12  
ADF cover..... 12  
ADF cover open lever..... 12  
Auto Document Feeder.....9, 300  
Auto Reduce / Enlarge.....98

## B

Basic procedure..... 131, 167  
Basic procedure (Copy)..... 97  
Basic procedure (Fax)..... 111  
Basic procedure (Scanner)..... 147, 156  
Beeping pattern.....204  
Bypass tray..... 13, 106, 178, 184, 186

## C

Canceling a transmission..... 117  
Caster table..... 37, 38  
Changing the display language..... 66  
Checking a stored file..... 162  
Classic Application.....73  
Combine..... 102  
Combine 1 Side..... 103  
Combine 2 Sides.....104  
Combine printing.....136  
Computer..... 248  
Control panel..... 13, 65  
Copier..... 213  
Copy..... 74, 97  
Copy orientation..... 100  
Cover for installing an offline stapler..... 13  
Cover for the exposure glass.....13  
Creating a shared folder..... 147  
Custom size paper..... 106

## D

Data In indicator.....65  
Destination..... 254  
Direct Connection Group Owner Mode.....27  
Direct Connection Mode..... 26

Display panel.....65  
Document Server.... 109, 139, 140, 167, 170, 213,  
285  
Drum unit..... 15  
Duplex..... 99

## E

E-mail address..... 156, 158, 159  
E-mail destination.....156, 158, 159  
ENERGY STAR Program.....271  
Envelope..... 107, 138, 186, 193  
Environmental advice for users..... 277  
Ethernet..... 18  
Ethernet port..... 15  
Expansion card slots..... 15  
Exposure glass..... 13  
Extended USB board..... 50  
Extender for the ADF tray..... 13  
Extender for the bypass tray..... 14  
External options.....37, 38  
External telephone connector..... 14

## F

Faceplate..... 17  
Facsimile.....215, 286  
Fax.....76  
Fax destination.....111, 114  
Fax indicator..... 65  
File Format Converter.....57  
File type..... 164  
Folder destination..... 150, 152, 153, 154, 155  
Front cover..... 13  
Front cover open button..... 13  
Function Compatibility..... 212  
Fusing unit..... 16

## G

G3 interface unit connector..... 14

## H

Handset.....38, 60  
Handset slit..... 14  
Home screen.....67  
How to Read the Manuals.....7

---

## I

---

Icon.....	67
IEEE 1284 interface board.....	48
IEEE 1284 Interface Board.....	297
Immediate Transmission.....	116
Indicator lamp.....	202
Infrastructure Mode.....	24
Input tray for the ADF.....	12
Installing the Printer Driver.....	123, 127
Interface Settings.....	36
Internal tray.....	13

## L

---

Label paper.....	186
LDAP server.....	254
LED.....	17
Loading paper.....	175, 178
Logging in the machine.....	93, 254
Logging in/out the machine.....	93
Lower paper tray.....	13, 186
Lower Paper Tray.....	295, 296
Lower paper trays.....	37, 38

## M

---

Main power indicator.....	65
Main power switch.....	91
Managing documents.....	140
Media access lamp.....	65
Media slots.....	65
Memory.....	237
Memory Storage Device.....	143
Memory Transmission.....	111
Message. 206, 213, 215, 225, 228, 237, 248, 254	
Model-specific information.....	10

## N

---

Names of major features.....	9
Network setting.....	215
Note for the battery and/or accumulator symbol..	276
Notes to users in the state of California.....	278
Number of Sets.....	108

## O

---

Offline Stapler.....	43
OHP transparencies.....	186
One-Sided combine.....	103
Option Installation.....	39
Orientation-fixed paper.....	181
Original orientation.....	100
Output tray for the ADF.....	13

## P

---

Paper capacity.....	186
Paper Feed Unit.....	40
Paper guides.....	14
Paper size.....	186
Paper thickness.....	186
Paper trays.....	186
Paper type.....	186
Paper weight.....	186
PCL.....	123, 127
PCL 6.....	131, 135, 136
Placing originals.....	95
Power connector.....	14
Power switch.....	13
Print cartridge.....	15
Printer.....	131, 225, 290
Printer driver properties.....	130
Privilege.....	254
Problem.....	206
Program.....	88

## Q

---

Quick Application.....	73
Quick Print Release.....	141

## R

---

Rear cover.....	14
Rear cover open lever.....	14
Records.....	122
Region A.....	10
Region B.....	10
Remote Fax.....	215
Removing Jammed Paper.....	262, 268
Running out of toner.....	198

---

## S

Scan Settings.....	165
Scan to E-mail.....	156
Scan to Folder.....	147
Scanner.....	82, 147, 156, 160, 237, 248, 292
SD Card.....	58
Sending stored documents.....	120
Shared folder.....	147
Shortcut icon.....	67
Sleep mode.....	272
Slide switch.....	17
Slot.....	15
SMB folder.....	150, 152, 153, 154
Sort.....	108
Specifications for the Main Unit.....	279
Standard Application.....	73
Standard printing.....	131
Staple cartridge.....	17
Staple holder.....	17
Staple unit.....	17, 37, 38
Staple unit cradle.....	16
Stapling slot.....	17
Status icon.....	201
Status indicator.....	65
Stop fence.....	13
Stop fence for the ADF.....	13
Stored documents.....	120, 170
Storing a document.....	119
Storing data.....	109, 167
Storing documents.....	139
Storing scan files.....	160
Symbols.....	7

## T

Telephone Line.....	32, 33
Thick paper.....	192
Toner.....	196, 198
Translucent paper.....	186
Tray 1.....	13, 186
Two-Sided combine.....	104
Two-sided paper.....	181
Two-sided printing.....	135

## U

USB (Type B) Interface.....	30
USB device server.....	51
USB Device Server.....	301
USB Host Interface.....	15, 30
User certificate.....	254
User Code Authentication.....	93
User information on electrical and electronic equipment.....	274

## V

Ventilation holes.....	13
Vents.....	14

## W

Web Image Monitor.....	173
Wireless LAN.....	20
Wireless LAN interface board.....	47
Wireless LAN Interface Board.....	298

---

MEMO



---

MEMO

---

MEMO



